

**Анирап**



# FLOOR DRAINS

STAINLESS STEEL DRAINAGE SYSTEMS

[www.anupamworld.com](http://www.anupamworld.com)

Anupam Floor Drain Catalogue  
2018 Edition

Anupam is a Registered Trademark of Garg Sons India Pvt. Ltd.  
Copyright © 2018 Garg Sons India Pvt. Ltd. All Rights Reserved.  
Unauthorized copying of this catalogue or part of is prohibited.

Printed By: DESIGNO, Delhi, India

# ***Anupam***

*Quality is always the result of high intention,  
sincere effort, intelligent direction and skillfull execution;  
it represents the wise choice of many alternatives.  
Anupam creations exemplify all these in a nutshell.*

*Our floor drains are made of best quality materials  
that stand the test of time and designed in tune with  
best ergonomics to match your utmost convenience.*

*What's more these advanced floor drains bear  
the hallmark of excellence and portray  
an evolved dimension of its very own.*

*In essence it guarantees you about our  
long standing tradition of quality and gives  
the best value for your money,  
you always look forward to.*





### **Anupam Floor Drain: Making your life grand and glorious**

We believe that Great products are the outcome of innovation and make your life simple. Our creations are also planned and engineered to give you more convenience and freedom in everyday life.

Anupam Floor Drain comes with a host of desired innovative features and meets your expectations. Apart from its regular size and features we also deliver it with center hole and in different customise size, which are available on request.

This book underlines our effort to provide you important and qualitative information about Anupam Floor Drain's different features and offerings. We have also added some quick reference guide for your convenience in this regard.

Visit **[anupamworld.com](http://anupamworld.com)** for any further information on all our products.



# FLOOR DRAIN REFERENCE GUIDE

## Creativity In Action



**Made in India** India is a born leader, and like many of the countries leader have believed, India is destined to play an extremely important role in leading the world in the right direction. Anupam® products are proudly made in India and according to the Indian user and requirement.



**ISO 9001 Certified** Anupam®, an ISO 9001 certified company, is committed towards the quality of not only it's product but its manufacturing process as well.



**ISO14000 Certified** With the same philosophy as for its quality system, Anupam® is dedicated to the protection of the environment and therefore is certified according to ISO 14001 environmental certificates.



**OSHAS 18000 Certified**  
Anupam® is OHSAS 18001 (Occupational Health and Safety Assessment Series) certified. OHSAS 18001 is an internationally recognised standard for occupational health and safety management which aims at reducing risks in the working environment.



**AISI-304 Grade** Anupam® Floor Drain are made from premium-grade AISI-304 steel, a heavy-duty material, for the high level of durability and reliability.



**1.5mm Thickness**  
The thickness of the stainless steel is probably the main point to check when buying a Floor Drain . The thicker the steel, the less susceptible it is to denting, bowing, noise, temperature changes and damage.



**1.0mm Thickness**  
Anupam® uses 1mm thick steel for the some of its models. This makes the Floor Drain less vulnerable to denting and bending.















**25 Years Of Excellence** We cherish the glory of more than 25 years of trust and value addition. Premium quality is the binding force of relationship between Anupam® and our valuable customers. We reflect a new definition of luxury, bliss and fanciful life with a special touch of innovation.

**Анират**



# CONTENT

Linea		06 - 11
Dritto		12 - 13
Tiara		18 - 23
Luxus		24 - 29
Elegante		30 - 35
Fluctus		36 - 41
Obliquo		42 - 47
Quadro		48 - 53
Floro		54 - 59
Arcus		60 - 66
Tile Insert		68 - 71
Floor Grating		72 - 85







**Анирати**

**LINEA**



[www.anupamworld.com](http://www.anupamworld.com)

Grating Thickness 1.5mm & Frame Thickness 1.0mm



**LINEAR DRAIN**

MODEL CODE	LENGTH	WIDTH	HEIGHT	OUTLET	PRICE ₹
AL-3010-11	300mm	100mm	40mm	50mm	4,990/-
AL-4510-11	450mm	100mm	40mm	50mm	5,790/-
AL-6010-11	600mm	100mm	40mm	50mm	6,490/-
AL-7510-11	750mm	100mm	40mm	50mm	7,290/-
AL-9010-11	900mm	100mm	40mm	50mm	7,990/-
AL-10510-11	1050mm	100mm	40mm	50mm	9,290/-
AL-12010-11	1200mm	100mm	40mm	50mm	10,990/-

\*Centre Hole and different customise size are also available on request.

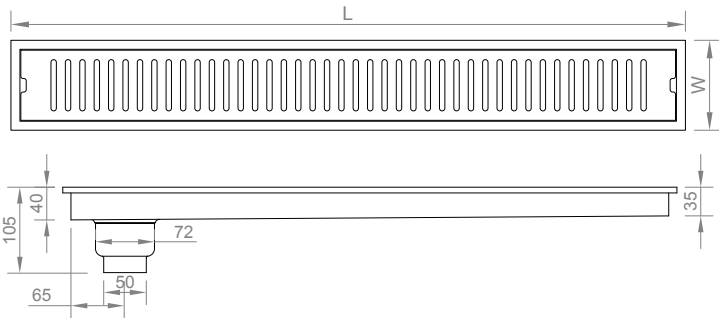

**TRIANGLE DRAIN**

MODEL CODE	LENGTH	WIDTH	HEIGHT	OUTLET	PRICE ₹
AT-3030-11	300mm	300mm	25mm	90mm	5,990/-

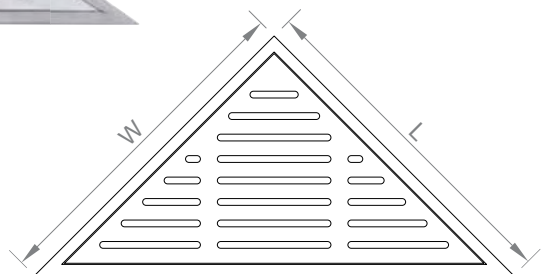
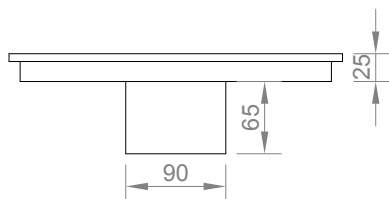





**Анупам**

**LINEA**

Grating Thickness 1.5mm & Frame Thickness 1.0mm

**SQUARE DRAIN**

MODEL CODE	LENGTH	WIDTH	HEIGHT	OUTLET	PRICE ₹
AS-1515-11	150mm	150mm	25mm	90mm	4,490/-
AS-2020-11	200mm	200mm	25mm	90mm	5,790/-
AS-2525-11	250mm	250mm	25mm	90mm	6,990/-
AS-3030-11	300mm	300mm	25mm	90mm	7,990/-

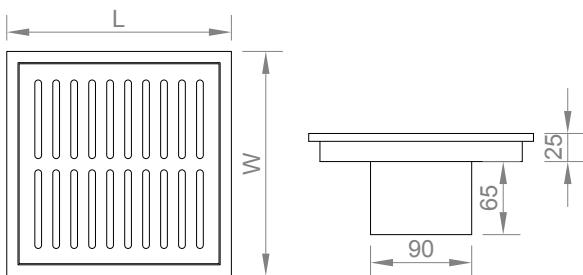

**Анупам**

**LINEA DELUXE**



Grating Thickness 1.5mm & Frame Thickness 1.5mm



**LINEAR DRAIN**

MODEL CODE	LENGTH	WIDTH	HEIGHT	OUTLET	PRICE ₹
AL-3010-11-DX	300mm	100mm	40mm	50mm	5,490/-
AL-4510-11-DX	450mm	100mm	40mm	50mm	6,390/-
AL-6010-11-DX	600mm	100mm	40mm	50mm	7,190/-
AL-7510-11-DX	750mm	100mm	40mm	50mm	7,990/-
AL-9010-11-DX	900mm	100mm	40mm	50mm	8,790/-
AL-10510-11-DX	1050mm	100mm	40mm	50mm	9,990/-
AL-12010-11-DX	1200mm	100mm	40mm	50mm	11,990/-

\*Centre Hole and different customise size are also available on request.

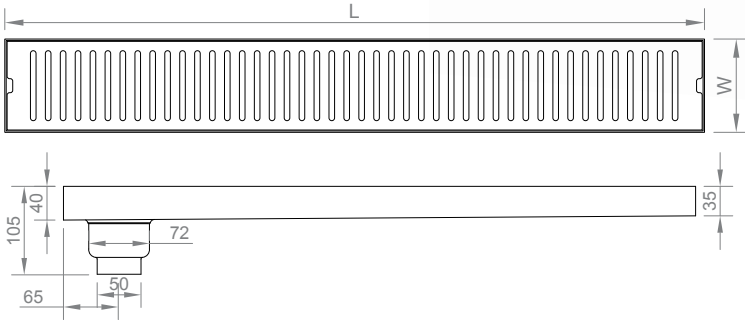

**SQUARE DRAIN**

MODEL CODE	LENGTH	WIDTH	HEIGHT	OUTLET	PRICE ₹
AS-1515-11-DX	150mm	150mm	25mm	90mm	4,990/-
AS-2020-11-DX	200mm	200mm	25mm	90mm	6,390/-
AS-2525-11-DX	250mm	250mm	25mm	90mm	7,690/-
AS-3030-11-DX	300mm	300mm	25mm	90mm	8,790/-

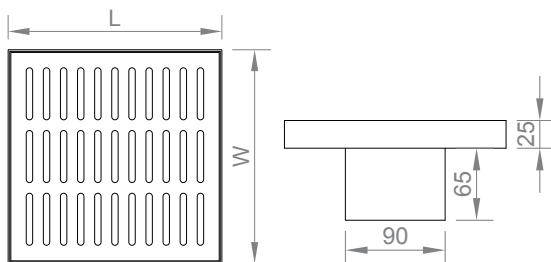

**TRIANGLE DRAIN**

MODEL CODE	LENGTH	WIDTH	HEIGHT	OUTLET	PRICE ₹
AT-3030-11-DX	300mm	300mm	25mm	90mm	6,990/-

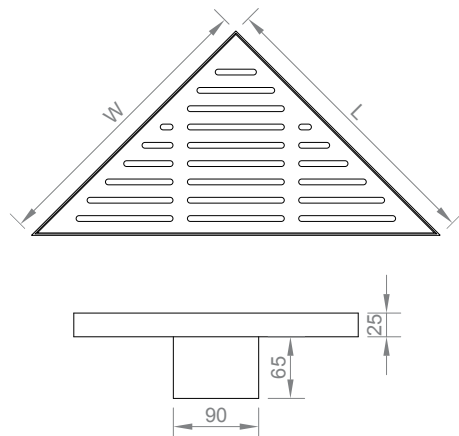





***Анира***

**DRITTO**



[www.anupamworld.com](http://www.anupamworld.com)

Grating Thickness 1.5mm & Frame Thickness 1.0mm



**LINEAR DRAIN**

MODEL CODE	LENGTH	WIDTH	HEIGHT	OUTLET	PRICE ₹
AL-3010-22	300mm	100mm	40mm	50mm	4,990/-
AL-4510-22	450mm	100mm	40mm	50mm	5,790/-
AL-6010-22	600mm	100mm	40mm	50mm	6,490/-
AL-7510-22	750mm	100mm	40mm	50mm	7,290/-
AL-9010-22	900mm	100mm	40mm	50mm	7,990/-
AL-10510-22	1050mm	100mm	40mm	50mm	9,290/-
AL-12010-22	1200mm	100mm	40mm	50mm	10,990/-

\*Centre Hole and different customise size are also available on request.

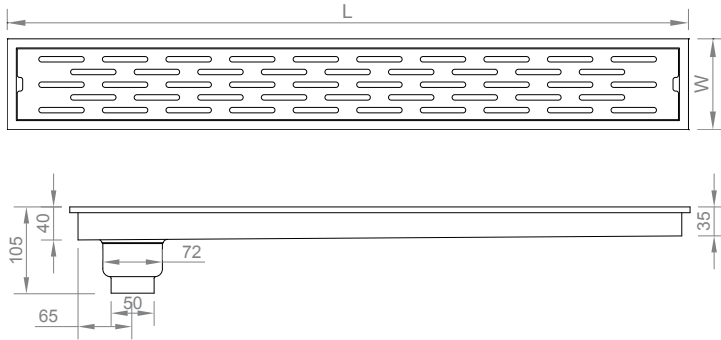

**TRIANGLE DRAIN**

MODEL CODE	LENGTH	WIDTH	HEIGHT	OUTLET	PRICE ₹
AT-3030-22	300mm	300mm	25mm	90mm	5,990/-

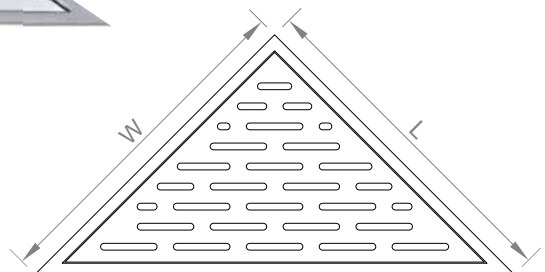
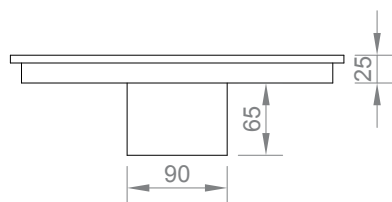





**Анупам**

**DRITTO**

Grating Thickness 1.5mm & Frame Thickness 1.0mm

**SQUARE DRAIN**

MODEL CODE	LENGTH	WIDTH	HEIGHT	OUTLET	PRICE ₹
AS-1515-22	150mm	150mm	25mm	90mm	4,490/-
AS-2020-22	200mm	200mm	25mm	90mm	5,790/-
AS-2525-22	250mm	250mm	25mm	90mm	6,990/-
AS-3030-22	300mm	300mm	25mm	90mm	7,990/-

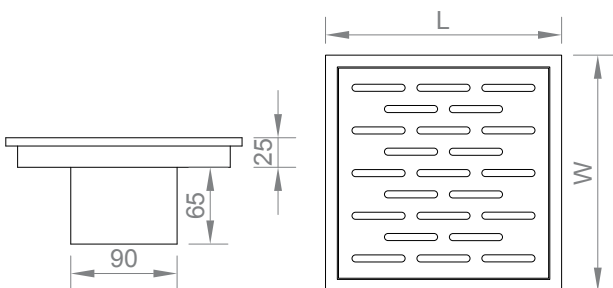



**Анупам**

**DRITTO DELUXE**

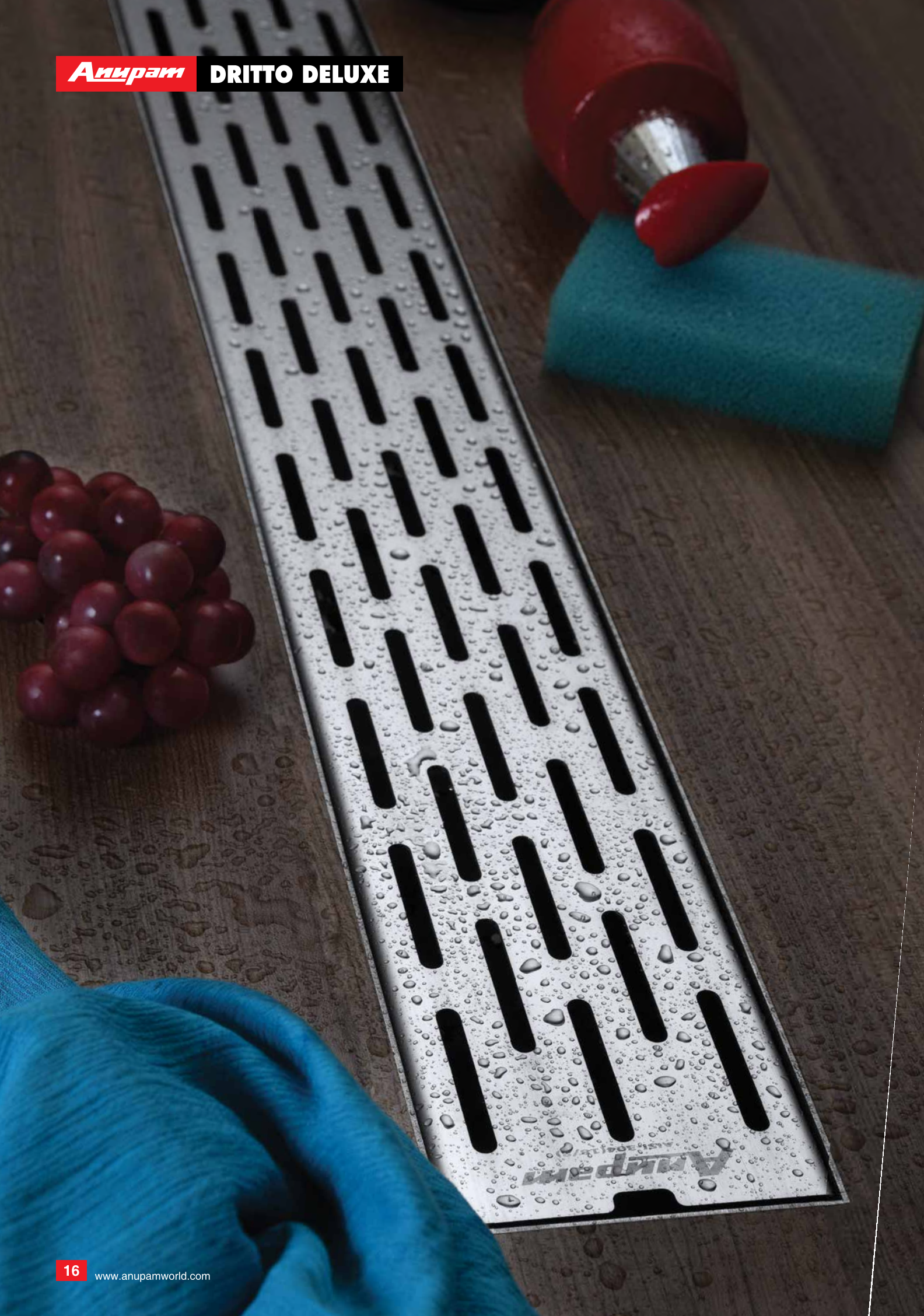

Grating Thickness 1.5mm & Frame Thickness 1.5mm



**LINEAR DRAIN**

MODEL CODE	LENGTH	WIDTH	HEIGHT	OUTLET	PRICE ₹
AL-3010-22-DX	300mm	100mm	40mm	50mm	5,490/-
AL-4510-22-DX	450mm	100mm	40mm	50mm	6,390/-
AL-6010-22-DX	600mm	100mm	40mm	50mm	7,190/-
AL-7510-22-DX	750mm	100mm	40mm	50mm	7,990/-
AL-9010-22-DX	900mm	100mm	40mm	50mm	8,790/-
AL-10510-22-DX	1050mm	100mm	40mm	50mm	9,990/-
AL-12010-22-DX	1200mm	100mm	40mm	50mm	11,990/-

\*Centre Hole and different customise size are also available on request.

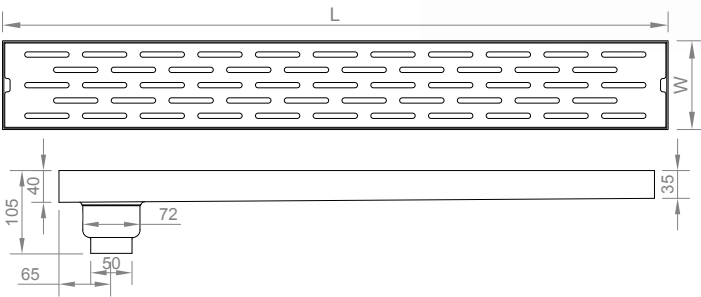

**SQUARE DRAIN**

MODEL CODE	LENGTH	WIDTH	HEIGHT	OUTLET	PRICE ₹
AS-1515-22-DX	150mm	150mm	25mm	90mm	4,990/-
AS-2020-22-DX	200mm	200mm	25mm	90mm	6,390/-
AS-2525-22-DX	250mm	250mm	25mm	90mm	7,690/-
AS-3030-22-DX	300mm	300mm	25mm	90mm	8,790/-

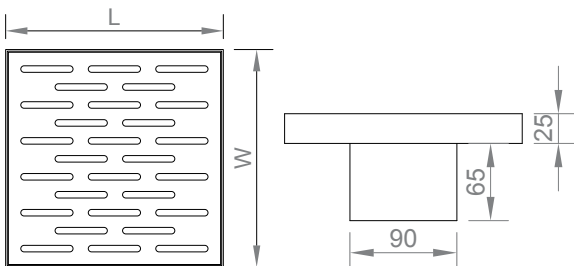

**TRIANGLE DRAIN**

MODEL CODE	LENGTH	WIDTH	HEIGHT	OUTLET	PRICE ₹
AT-3030-22-DX	300mm	300mm	25mm	90mm	6,990/-

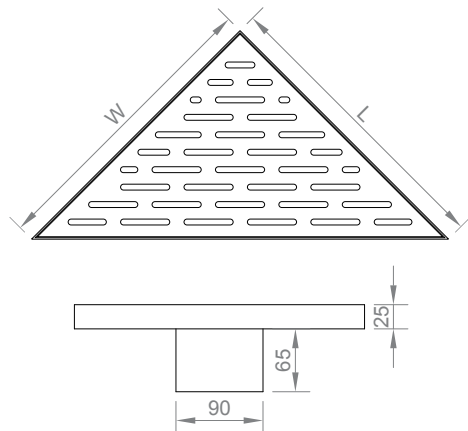





***Анирати***

# **TIARA**



[www.anupamworld.com](http://www.anupamworld.com)

Grating Thickness 1.5mm & Frame Thickness 1.0mm



**LINEAR DRAIN**

MODEL CODE	LENGTH	WIDTH	HEIGHT	OUTLET	PRICE ₹
AL-3010-33	300mm	100mm	40mm	50mm	4,990/-
AL-4510-33	450mm	100mm	40mm	50mm	5,790/-
AL-6010-33	600mm	100mm	40mm	50mm	6,490/-
AL-7510-33	750mm	100mm	40mm	50mm	7,290/-
AL-9010-33	900mm	100mm	40mm	50mm	7,990/-
AL-10510-33	1050mm	100mm	40mm	50mm	9,290/-
AL-12010-33	1200mm	100mm	40mm	50mm	10,990/-

\*Centre Hole and different customise size are also available on request.

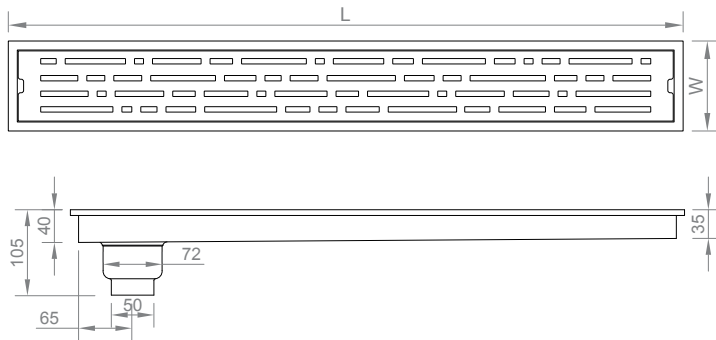

**TRIANGLE DRAIN**

MODEL CODE	LENGTH	WIDTH	HEIGHT	OUTLET	PRICE ₹
AT-3030-33	300mm	300mm	25mm	90mm	5,990/-

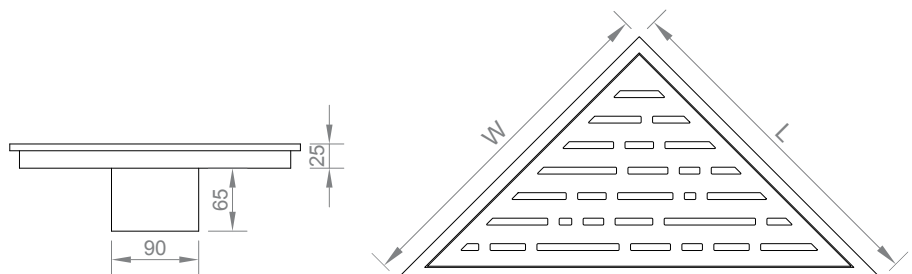



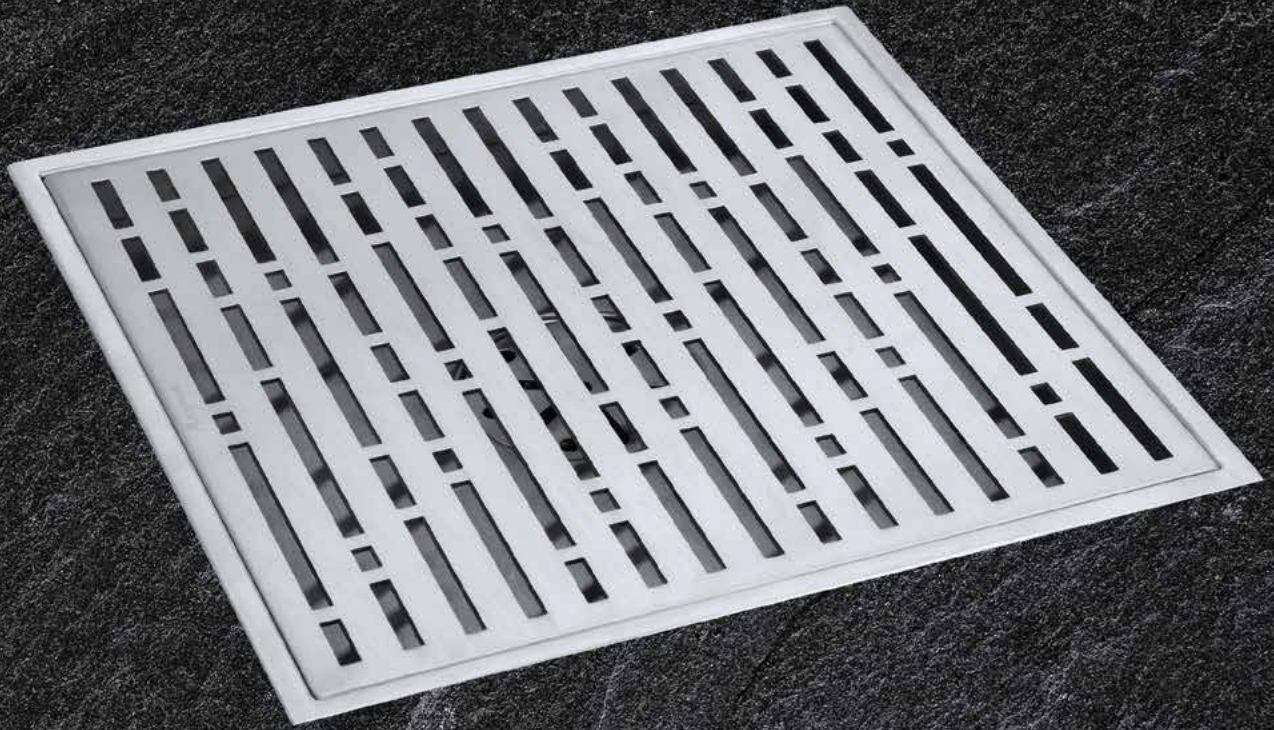

**Anupam**

**TIARA**

Grating Thickness 1.5mm & Frame Thickness 1.0mm

**SQUARE DRAIN**

MODEL CODE	LENGTH	WIDTH	HEIGHT	OUTLET	PRICE ₹
AS-1515-33	150mm	150mm	25mm	90mm	4,490/-
AS-2020-33	200mm	200mm	25mm	90mm	5,790/-
AS-2525-33	250mm	250mm	25mm	90mm	6,990/-
AS-3030-33	300mm	300mm	25mm	90mm	7,990/-

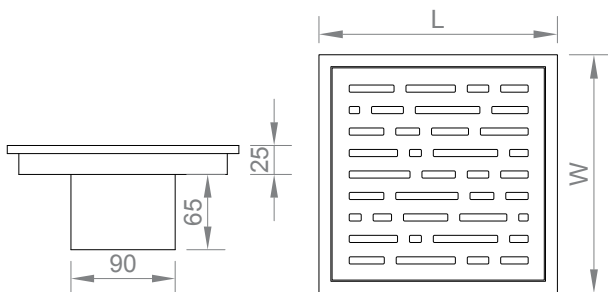



**Анупам** TIARA DELUXE

Анупам  
AISI-304(18/8)

Grating Thickness 1.5mm & Frame Thickness 1.5mm



**LINEAR DRAIN**

MODEL CODE	LENGTH	WIDTH	HEIGHT	OUTLET	PRICE ₹
AL-3010-33-DX	300mm	100mm	40mm	50mm	5,490/-
AL-4510-33-DX	450mm	100mm	40mm	50mm	6,390/-
AL-6010-33-DX	600mm	100mm	40mm	50mm	7,190/-
AL-7510-33-DX	750mm	100mm	40mm	50mm	7,990/-
AL-9010-33-DX	900mm	100mm	40mm	50mm	8,790/-
AL-10510-33-DX	1050mm	100mm	40mm	50mm	9,990/-
AL-12010-33-DX	1200mm	100mm	40mm	50mm	11,990/-

\*Centre Hole and different customise size are also available on request.

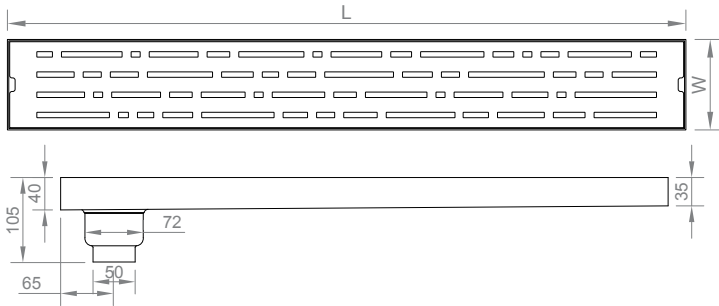

**SQUARE DRAIN**

MODEL CODE	LENGTH	WIDTH	HEIGHT	OUTLET	PRICE ₹
AS-1515-33-DX	150mm	150mm	25mm	90mm	4,990/-
AS-2020-33-DX	200mm	200mm	25mm	90mm	6,390/-
AS-2525-33-DX	250mm	250mm	25mm	90mm	7,690/-
AS-3030-33-DX	300mm	300mm	25mm	90mm	8,790/-

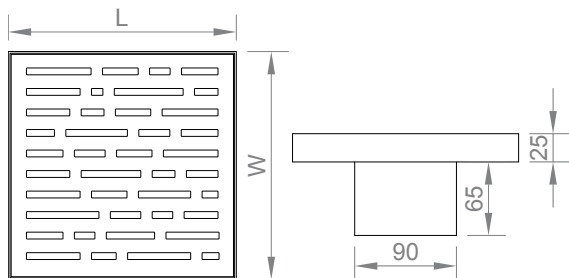

**TRIANGLE DRAIN**

MODEL CODE	LENGTH	WIDTH	HEIGHT	OUTLET	PRICE ₹
AT-3030-33-DX	300mm	300mm	25mm	90mm	6,990/-

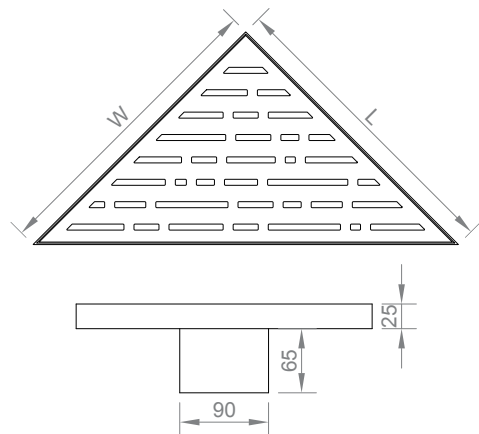





***Анират***

**LUXUS**



[www.anupamworld.com](http://www.anupamworld.com)

Grating Thickness 1.5mm & Frame Thickness 1.0mm



**LINEAR DRAIN**

MODEL CODE	LENGTH	WIDTH	HEIGHT	OUTLET	PRICE ₹
AL-3010-44	300mm	100mm	40mm	50mm	4,990/-
AL-4510-44	450mm	100mm	40mm	50mm	5,790/-
AL-6010-44	600mm	100mm	40mm	50mm	6,490/-
AL-7510-44	750mm	100mm	40mm	50mm	7,290/-
AL-9010-44	900mm	100mm	40mm	50mm	7,990/-
AL-10510-44	1050mm	100mm	40mm	50mm	9,290/-
AL-12010-44	1200mm	100mm	40mm	50mm	10,990/-

\*Centre Hole and different customise size are also available on request.

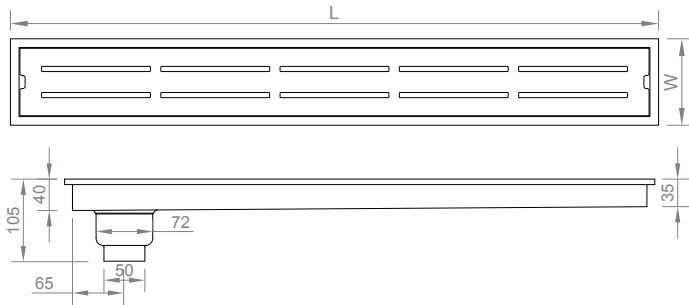

**TRIANGLE DRAIN**

MODEL CODE	LENGTH	WIDTH	HEIGHT	OUTLET	PRICE ₹
AT-3030-44	300mm	300mm	25mm	90mm	5,990/-

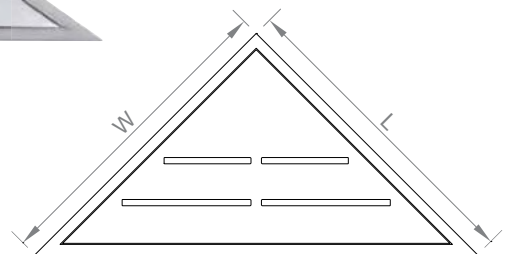
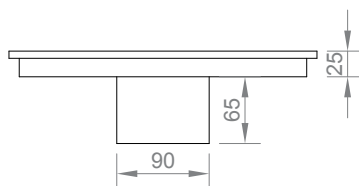





Grating Thickness 1.5mm & Frame Thickness 1.0mm

**SQUARE DRAIN**

MODEL CODE	LENGTH	WIDTH	HEIGHT	OUTLET	PRICE ₹
AS-1515-44	150mm	150mm	25mm	90mm	4,490/-
AS-2020-44	200mm	200mm	25mm	90mm	5,790/-
AS-2525-44	250mm	250mm	25mm	90mm	6,990/-
AS-3030-44	300mm	300mm	25mm	90mm	7,990/-

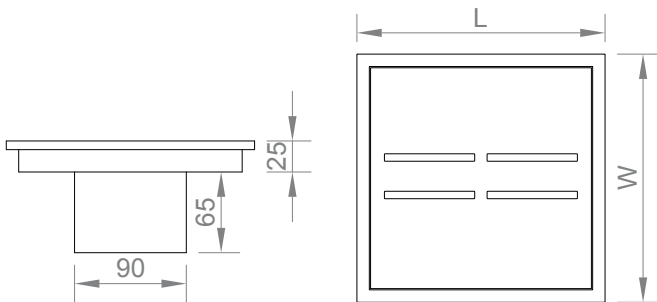



**Анупам LUXUS DELUXE**



Grating Thickness 1.5mm & Frame Thickness 1.5mm



LINEAR DRAIN					
MODEL CODE	LENGTH	WIDTH	HEIGHT	OUTLET	PRICE ₹
AL-3010-44-DX	300mm	100mm	40mm	50mm	5,490/-
AL-4510-44-DX	450mm	100mm	40mm	50mm	6,390/-
AL-6010-44-DX	600mm	100mm	40mm	50mm	7,190/-
AL-7510-44-DX	750mm	100mm	40mm	50mm	7,990/-
AL-9010-44-DX	900mm	100mm	40mm	50mm	8,790/-
AL-10510-44-DX	1050mm	100mm	40mm	50mm	9,990/-
AL-12010-44-DX	1200mm	100mm	40mm	50mm	11,990/-

\*Centre Hole and different customise size are also available on request.

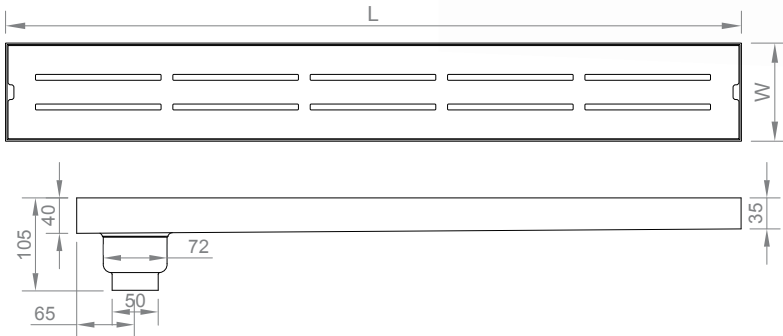

SQUARE DRAIN					
MODEL CODE	LENGTH	WIDTH	HEIGHT	OUTLET	PRICE ₹
AS-1515-44-DX	150mm	150mm	25mm	90mm	4,990/-
AS-2020-44-DX	200mm	200mm	25mm	90mm	6,390/-
AS-2525-44-DX	250mm	250mm	25mm	90mm	7,690/-
AS-3030-44-DX	300mm	300mm	25mm	90mm	8,790/-

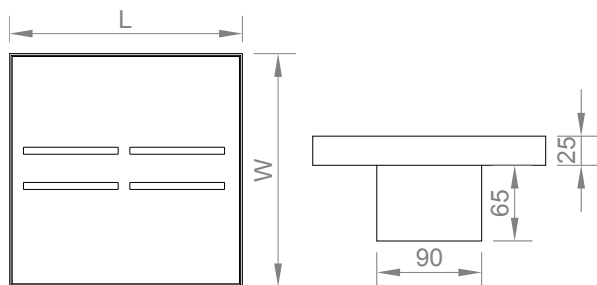

TRIANGLE DRAIN					
MODEL CODE	LENGTH	WIDTH	HEIGHT	OUTLET	PRICE ₹
AT-3030-44-DX	300mm	300mm	25mm	90mm	6,990/-

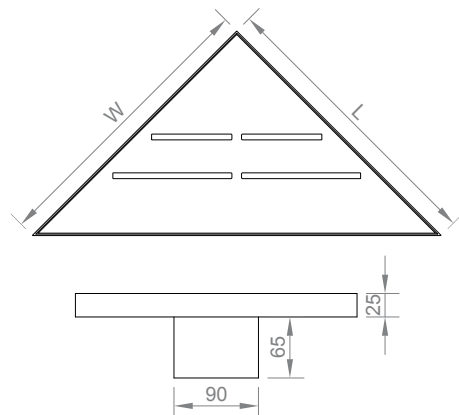



**Анупам**

**ELEGANTE**



**Анираж**

**ELEGANTE**



[www.anupamworld.com](http://www.anupamworld.com)

Grating Thickness 1.5mm & Frame Thickness 1.0mm



**LINEAR DRAIN**

MODEL CODE	LENGTH	WIDTH	HEIGHT	OUTLET	PRICE ₹
AL-3010-55	300mm	100mm	40mm	50mm	4,990/-
AL-4510-55	450mm	100mm	40mm	50mm	5,790/-
AL-6010-55	600mm	100mm	40mm	50mm	6,490/-
AL-7510-55	750mm	100mm	40mm	50mm	7,290/-
AL-9010-55	900mm	100mm	40mm	50mm	7,990/-
AL-10510-55	1050mm	100mm	40mm	50mm	9,290/-
AL-12010-55	1200mm	100mm	40mm	50mm	10,990/-

\*Centre Hole and different customise size are also available on request.

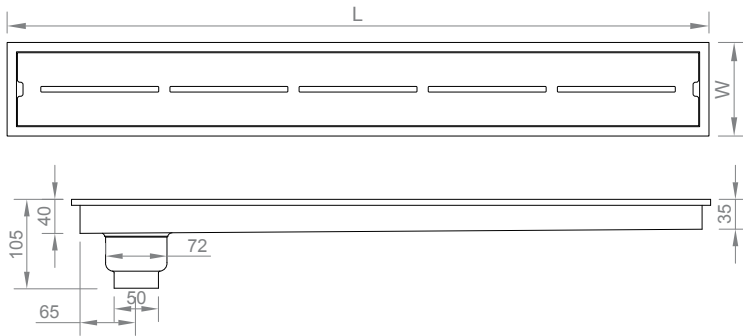

**TRIANGLE DRAIN**

MODEL CODE	LENGTH	WIDTH	HEIGHT	OUTLET	PRICE ₹
AT-3030-55	300mm	300mm	25mm	90mm	5,990/-

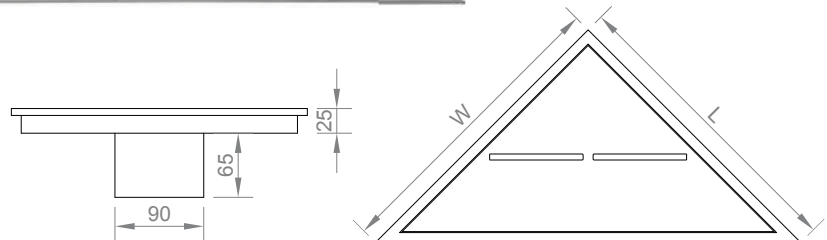





**Anupam ELEGANTE**

Grating Thickness 1.5mm & Frame Thickness 1.0mm

**SQUARE DRAIN**

MODEL CODE	LENGTH	WIDTH	HEIGHT	OUTLET	PRICE ₹
AS-1515-55	150mm	150mm	25mm	90mm	4,490/-
AS-2020-55	200mm	200mm	25mm	90mm	5,790/-
AS-2525-55	250mm	250mm	25mm	90mm	6,990/-
AS-3030-55	300mm	300mm	25mm	90mm	7,990/-

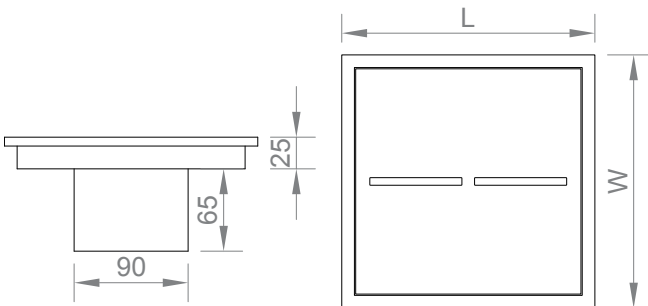



**Анупам**

**ELEGANTE DELUXE**



Grating Thickness 1.5mm & Frame Thickness 1.5mm



LINEAR DRAIN					
MODEL CODE	LENGTH	WIDTH	HEIGHT	OUTLET	PRICE ₹
AL-3010-55-DX	300mm	100mm	40mm	50mm	5,490/-
AL-4510-55-DX	450mm	100mm	40mm	50mm	6,390/-
AL-6010-55-DX	600mm	100mm	40mm	50mm	7,190/-
AL-7510-55-DX	750mm	100mm	40mm	50mm	7,990/-
AL-9010-55-DX	900mm	100mm	40mm	50mm	8,790/-
AL-10510-55-DX	1050mm	100mm	40mm	50mm	9,990/-
AL-12010-55-DX	1200mm	100mm	40mm	50mm	11,990/-

\*Centre Hole and different customise size are also available on request.

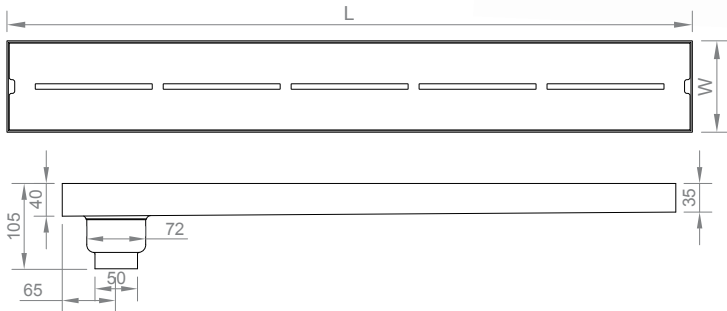

SQUARE DRAIN					
MODEL CODE	LENGTH	WIDTH	HEIGHT	OUTLET	PRICE ₹
AS-1515-55-DX	150mm	150mm	25mm	90mm	4,990/-
AS-2020-55-DX	200mm	200mm	25mm	90mm	6,390/-
AS-2525-55-DX	250mm	250mm	25mm	90mm	7,690/-
AS-3030-55-DX	300mm	300mm	25mm	90mm	8,790/-

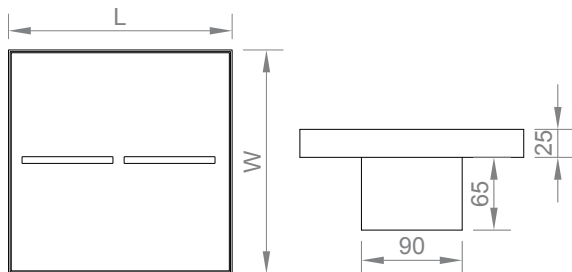

TRIANGLE DRAIN					
MODEL CODE	LENGTH	WIDTH	HEIGHT	OUTLET	PRICE ₹
AT-3030-55-DX	300mm	300mm	25mm	90mm	6,990/-

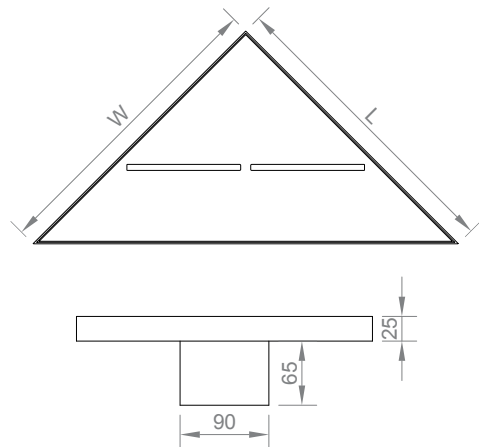



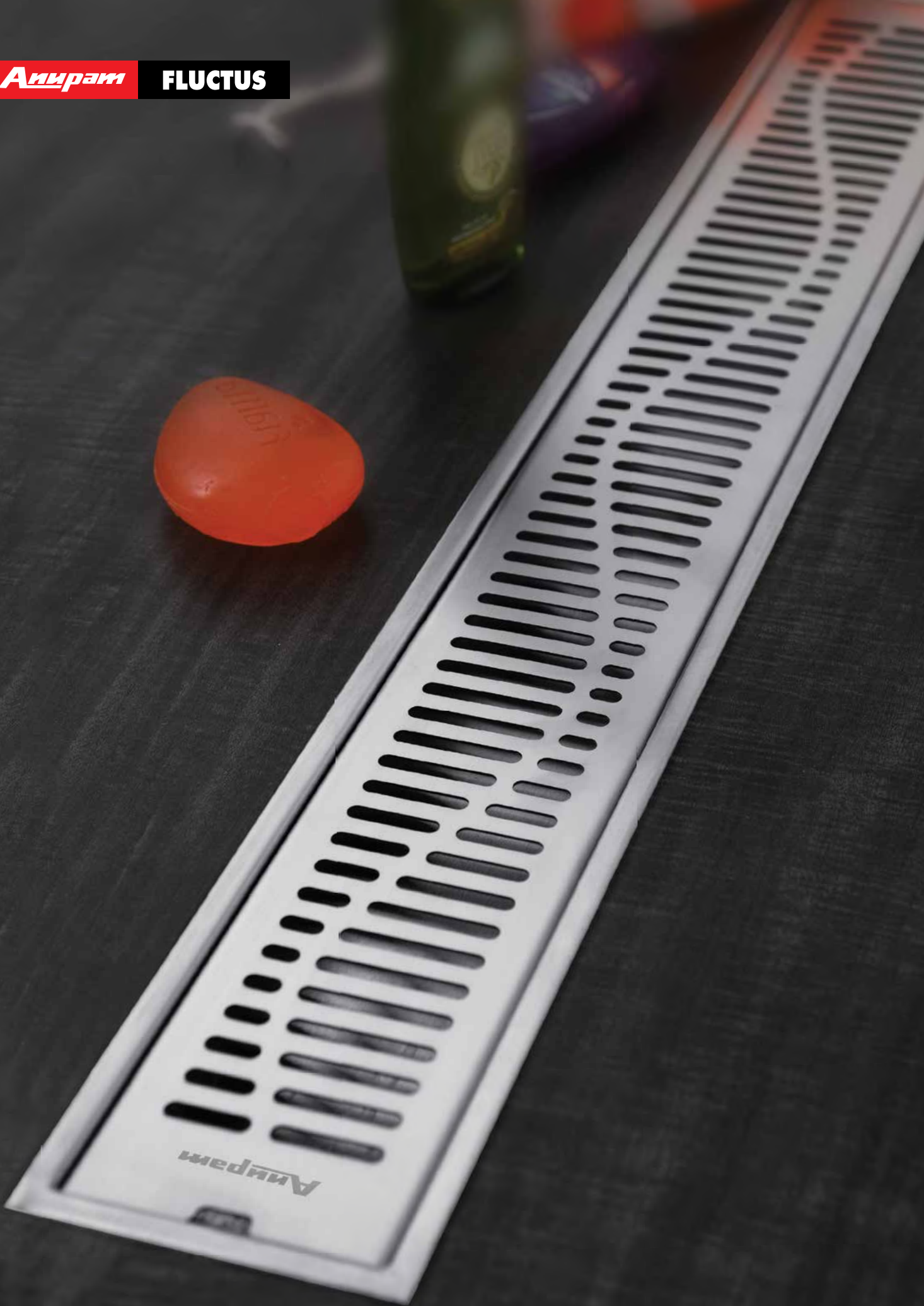

**Анират**

**FLUCTUS**



[www.anupamworld.com](http://www.anupamworld.com)

Grating Thickness 1.5mm & Frame Thickness 1.0mm



**LINEAR DRAIN**

MODEL CODE	LENGTH	WIDTH	HEIGHT	OUTLET	PRICE ₹
AL-3010-66	300mm	100mm	40mm	50mm	5,290/-
AL-4510-66	450mm	100mm	40mm	50mm	6,090/-
AL-6010-66	600mm	100mm	40mm	50mm	6,890/-
AL-7510-66	750mm	100mm	40mm	50mm	7,690/-
AL-9010-66	900mm	100mm	40mm	50mm	8,390/-
AL-10510-66	1050mm	100mm	40mm	50mm	9,690/-
AL-12010-66	1200mm	100mm	40mm	50mm	11,590/-

\*Centre Hole and different customise size are also available on request.

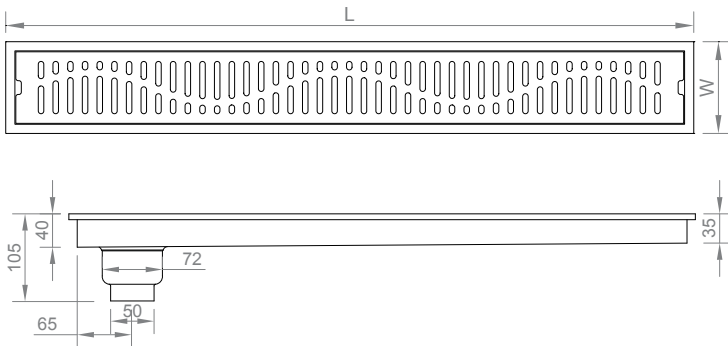

**TRIANGLE DRAIN**

MODEL CODE	LENGTH	WIDTH	HEIGHT	OUTLET	PRICE ₹
AT-3030-66	300mm	300mm	25mm	90mm	6,290/-

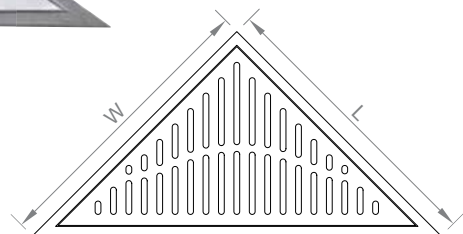
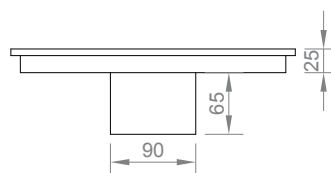





**Анупам** **FLUCTUS**

Grating Thickness 1.5mm & Frame Thickness 1.0mm

**SQUARE DRAIN**

MODEL CODE	LENGTH	WIDTH	HEIGHT	OUTLET	PRICE ₹
AS-1515-66	150mm	150mm	25mm	90mm	4,790/-
AS-2020-66	200mm	200mm	25mm	90mm	6,090/-
AS-2525-66	250mm	250mm	25mm	90mm	7,390/-
AS-3030-66	300mm	300mm	25mm	90mm	8,390/-

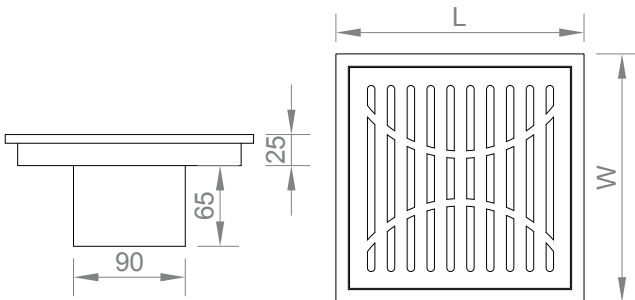



**Анупам**

**FLUCTUS DELUXE**



Grating Thickness 1.5mm & Frame Thickness 1.5mm



**LINEAR DRAIN**

MODEL CODE	LENGTH	WIDTH	HEIGHT	OUTLET	PRICE ₹
AL-3010-66-DX	300mm	100mm	40mm	50mm	5,790/-
AL-4510-66-DX	450mm	100mm	40mm	50mm	6,690/-
AL-6010-66-DX	600mm	100mm	40mm	50mm	7,590/-
AL-7510-66-DX	750mm	100mm	40mm	50mm	8,490/-
AL-9010-66-DX	900mm	100mm	40mm	50mm	9,190/-
AL-10510-66-DX	1050mm	100mm	40mm	50mm	10,690/-
AL-12010-66-DX	1200mm	100mm	40mm	50mm	12,790/-

\*Centre Hole and different customise size are also available on request.

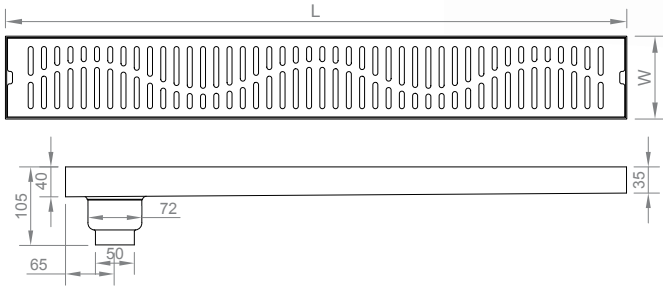

**SQUARE DRAIN**

MODEL CODE	LENGTH	WIDTH	HEIGHT	OUTLET	PRICE ₹
AS-1515-66-DX	150mm	150mm	25mm	90mm	5,290/-
AS-2020-66-DX	200mm	200mm	25mm	90mm	6,690/-
AS-2525-66-DX	250mm	250mm	25mm	90mm	8,190/-
AS-3030-66-DX	300mm	300mm	25mm	90mm	9,290/-

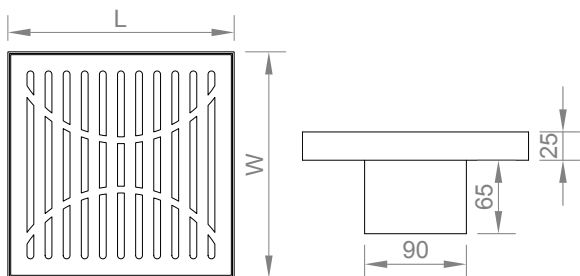

**TRIANGLE DRAIN**

MODEL CODE	LENGTH	WIDTH	HEIGHT	OUTLET	PRICE ₹
AT-3030-66-DX	300mm	300mm	25mm	90mm	7,390/-

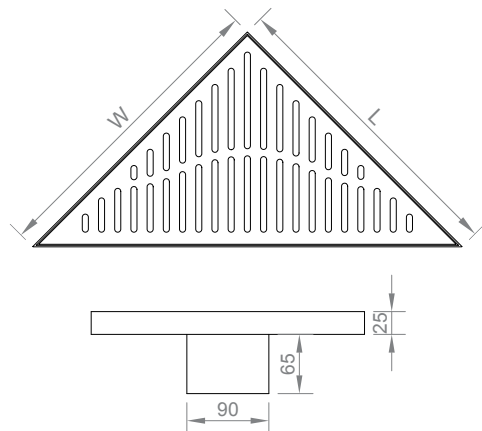







**Аниран**

**OBLIQUO**

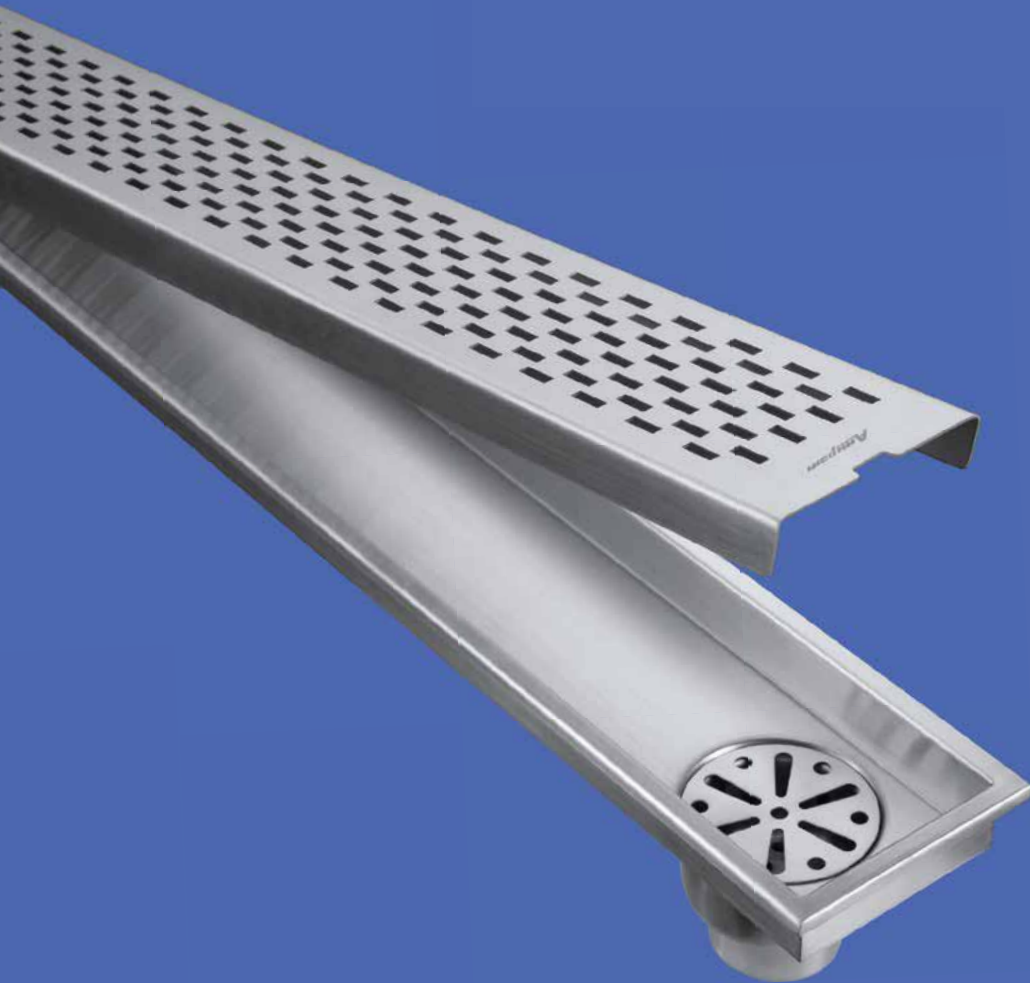

[www.anupamworld.com](http://www.anupamworld.com)

Grating Thickness 1.5mm & Frame Thickness 1.0mm



LINEAR DRAIN					
MODEL CODE	LENGTH	WIDTH	HEIGHT	OUTLET	PRICE ₹
AL-3010-77	300mm	100mm	40mm	50mm	5,290/-
AL-4510-77	450mm	100mm	40mm	50mm	6,090/-
AL-6010-77	600mm	100mm	40mm	50mm	6,890/-
AL-7510-77	750mm	100mm	40mm	50mm	7,690/-
AL-9010-77	900mm	100mm	40mm	50mm	8,390/-
AL-10510-77	1050mm	100mm	40mm	50mm	9,690/-
AL-12010-77	1200mm	100mm	40mm	50mm	11,590/-

\*Centre Hole and different customise size are also available on request.

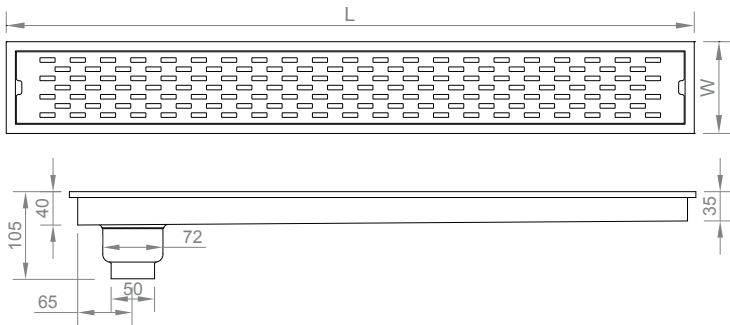

TRIANGLE DRAIN					
MODEL CODE	LENGTH	WIDTH	HEIGHT	OUTLET	PRICE ₹
AT-3030-77	300mm	300mm	25mm	90mm	6,290/-

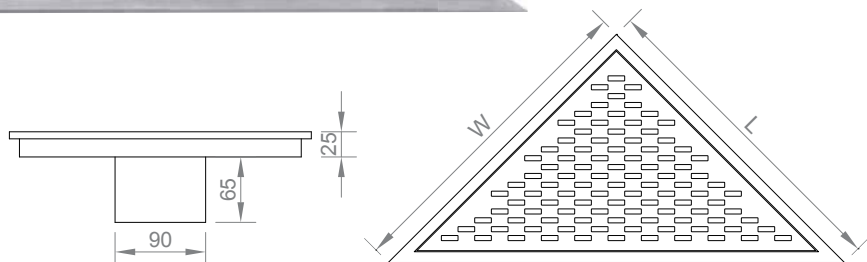
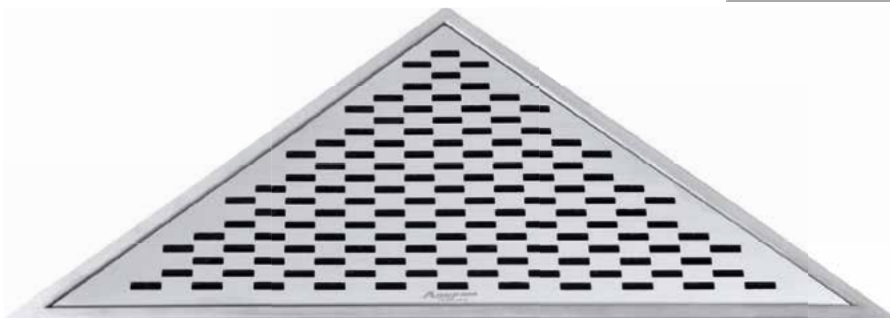



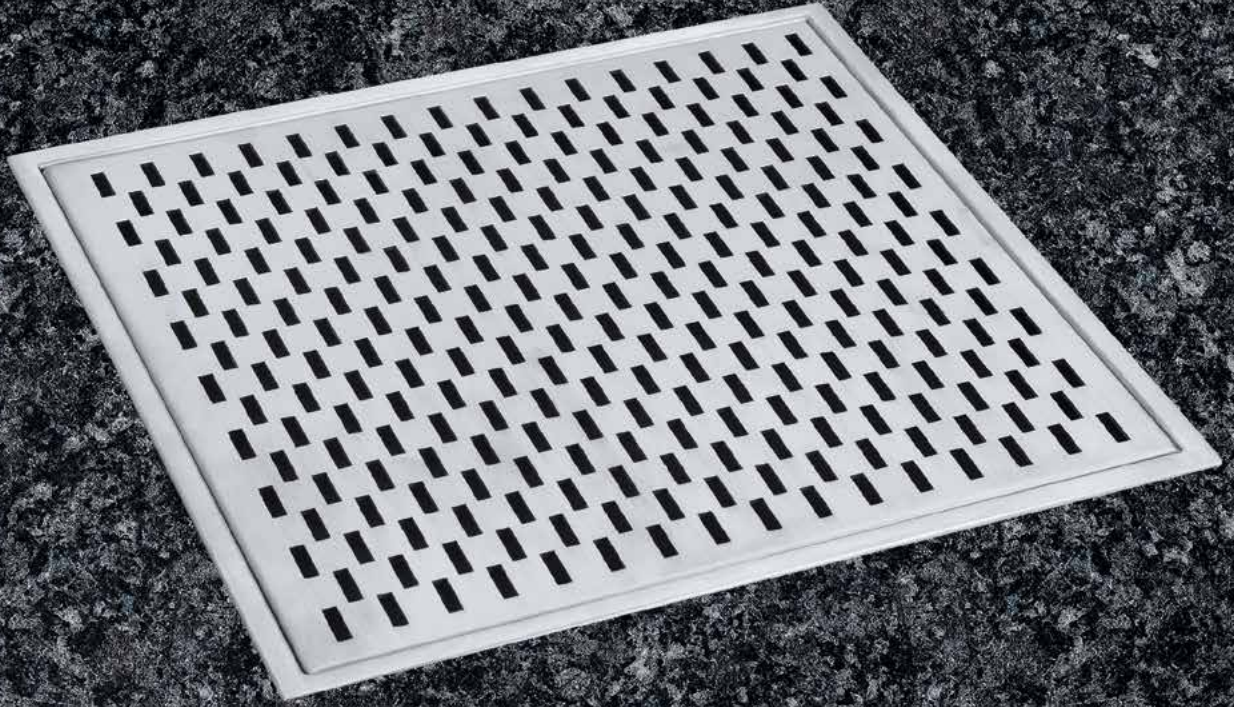

**Anupam** **OBLIQUO**

Grating Thickness 1.5mm & Frame Thickness 1.0mm

**SQUARE DRAIN**

MODEL CODE	LENGTH	WIDTH	HEIGHT	OUTLET	PRICE ₹
AS-1515-77	150mm	150mm	25mm	90mm	4,790/-
AS-2020-77	200mm	200mm	25mm	90mm	6,090/-
AS-2525-77	250mm	250mm	25mm	90mm	7,390/-
AS-3030-77	300mm	300mm	25mm	90mm	8,390/-

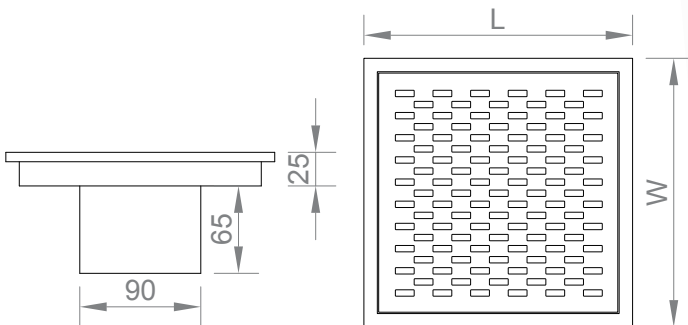



**Анупам** **OBLIQUO DELUXE**



Grating Thickness 1.5mm & Frame Thickness 1.5mm

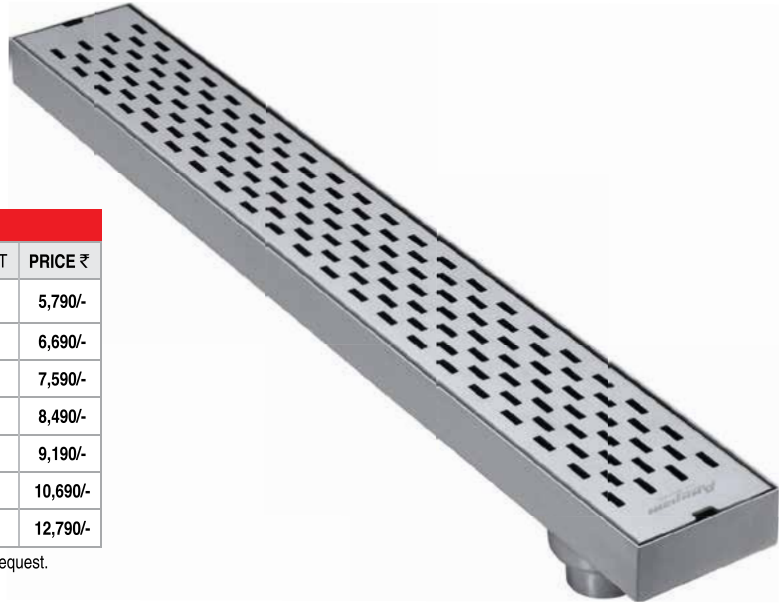

**LINEAR DRAIN**

MODEL CODE	LENGTH	WIDTH	HEIGHT	OUTLET	PRICE ₹
AL-3010-77-DX	300mm	100mm	40mm	50mm	5,790/-
AL-4510-77-DX	450mm	100mm	40mm	50mm	6,690/-
AL-6010-77-DX	600mm	100mm	40mm	50mm	7,590/-
AL-7510-77-DX	750mm	100mm	40mm	50mm	8,490/-
AL-9010-77-DX	900mm	100mm	40mm	50mm	9,190/-
AL-10510-77-DX	1050mm	100mm	40mm	50mm	10,690/-
AL-12010-77-DX	1200mm	100mm	40mm	50mm	12,790/-

\*Centre Hole and different customise size are also available on request.

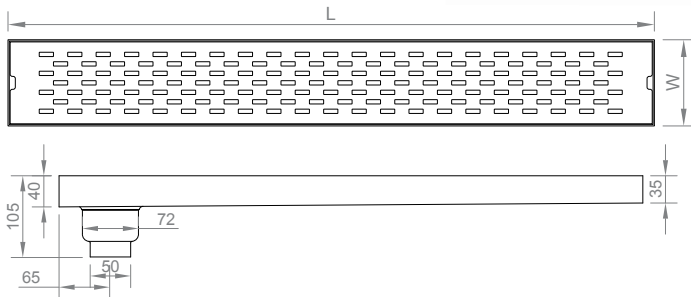

**SQUARE DRAIN**

MODEL CODE	LENGTH	WIDTH	HEIGHT	OUTLET	PRICE ₹
AS-1515-77-DX	150mm	150mm	25mm	90mm	5,290/-
AS-2020-77-DX	200mm	200mm	25mm	90mm	6,690/-
AS-2525-77-DX	250mm	250mm	25mm	90mm	8,190/-
AS-3030-77-DX	300mm	300mm	25mm	90mm	9,290/-

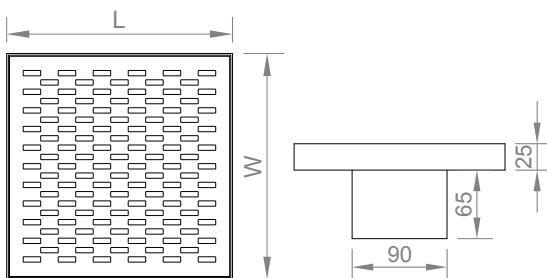

**TRIANGLE DRAIN**

MODEL CODE	LENGTH	WIDTH	HEIGHT	OUTLET	PRICE ₹
AT-3030-77-DX	300mm	300mm	25mm	90mm	7,390/-

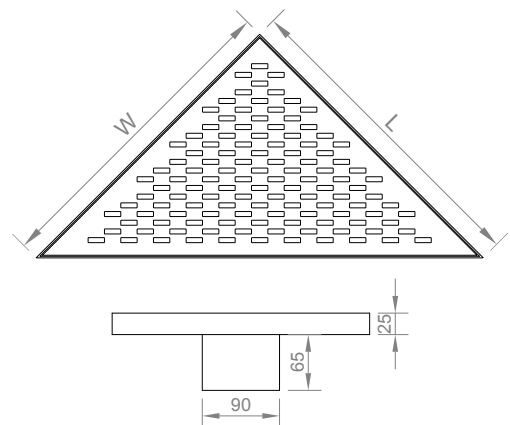





**Анупам**

**QUADRO**



[www.anupamworld.com](http://www.anupamworld.com)

Grating Thickness 1.5mm & Frame Thickness 1.0mm



**LINEAR DRAIN**

MODEL CODE	LENGTH	WIDTH	HEIGHT	OUTLET	PRICE ₹
AL-3010-88	300mm	100mm	40mm	50mm	5,490/-
AL-4510-88	450mm	100mm	40mm	50mm	6,390/-
AL-6010-88	600mm	100mm	40mm	50mm	7,190/-
AL-7510-88	750mm	100mm	40mm	50mm	7,990/-
AL-9010-88	900mm	100mm	40mm	50mm	8,790/-
AL-10510-88	1050mm	100mm	40mm	50mm	10,190/-
AL-12010-88	1200mm	100mm	40mm	50mm	11,990/-

\*Centre Hole and different customise size are also available on request.

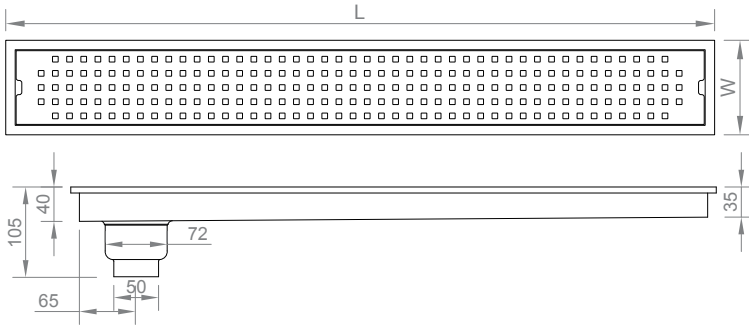

**TRIANGLE DRAIN**

MODEL CODE	LENGTH	WIDTH	HEIGHT	OUTLET	PRICE ₹
AT-3030-88	300mm	300mm	25mm	90mm	6,590/-

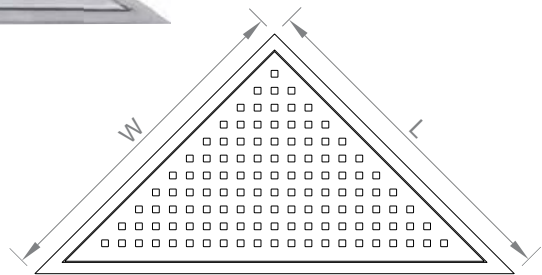
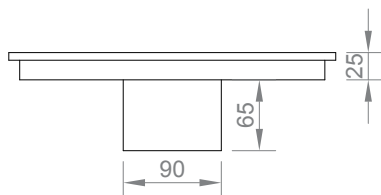
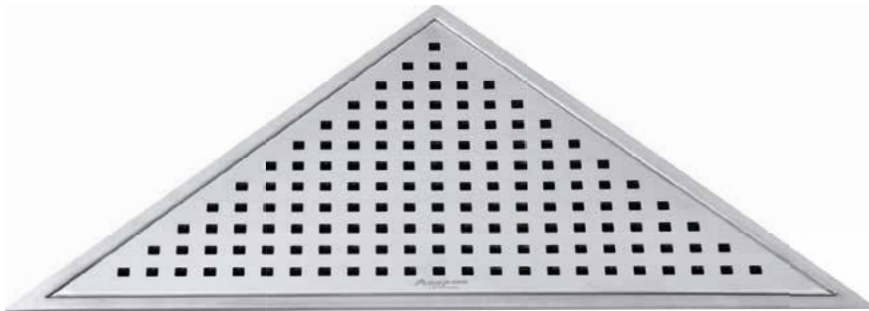



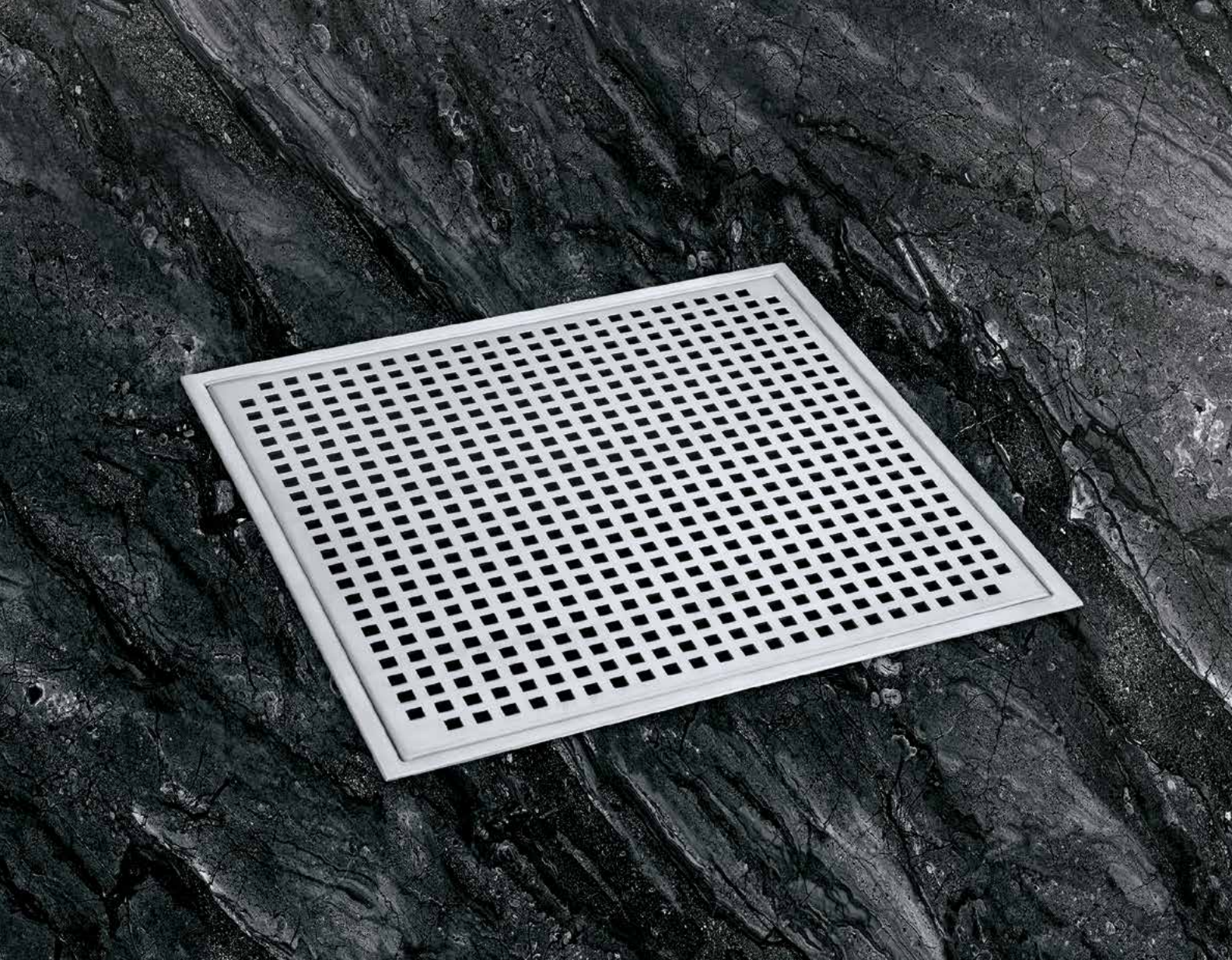

**Anupam QUADRO**

Grating Thickness 1.5mm & Frame Thickness 1.0mm

**SQUARE DRAIN**

MODEL CODE	LENGTH	WIDTH	HEIGHT	OUTLET	PRICE ₹
AS-1515-88	150mm	150mm	25mm	90mm	4,990/-
AS-2020-88	200mm	200mm	25mm	90mm	6,390/-
AS-2525-88	250mm	250mm	25mm	90mm	7,690/-
AS-3030-88	300mm	300mm	25mm	90mm	8,790/-

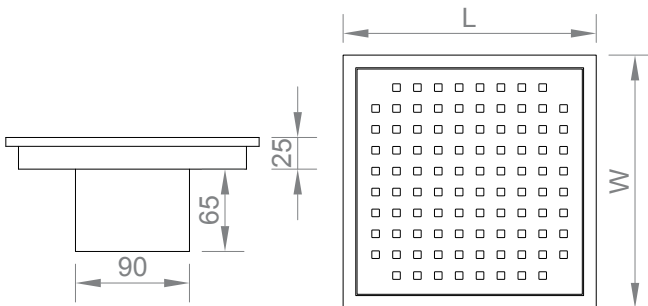



**Анупам**

**QUADRO DELUXE**

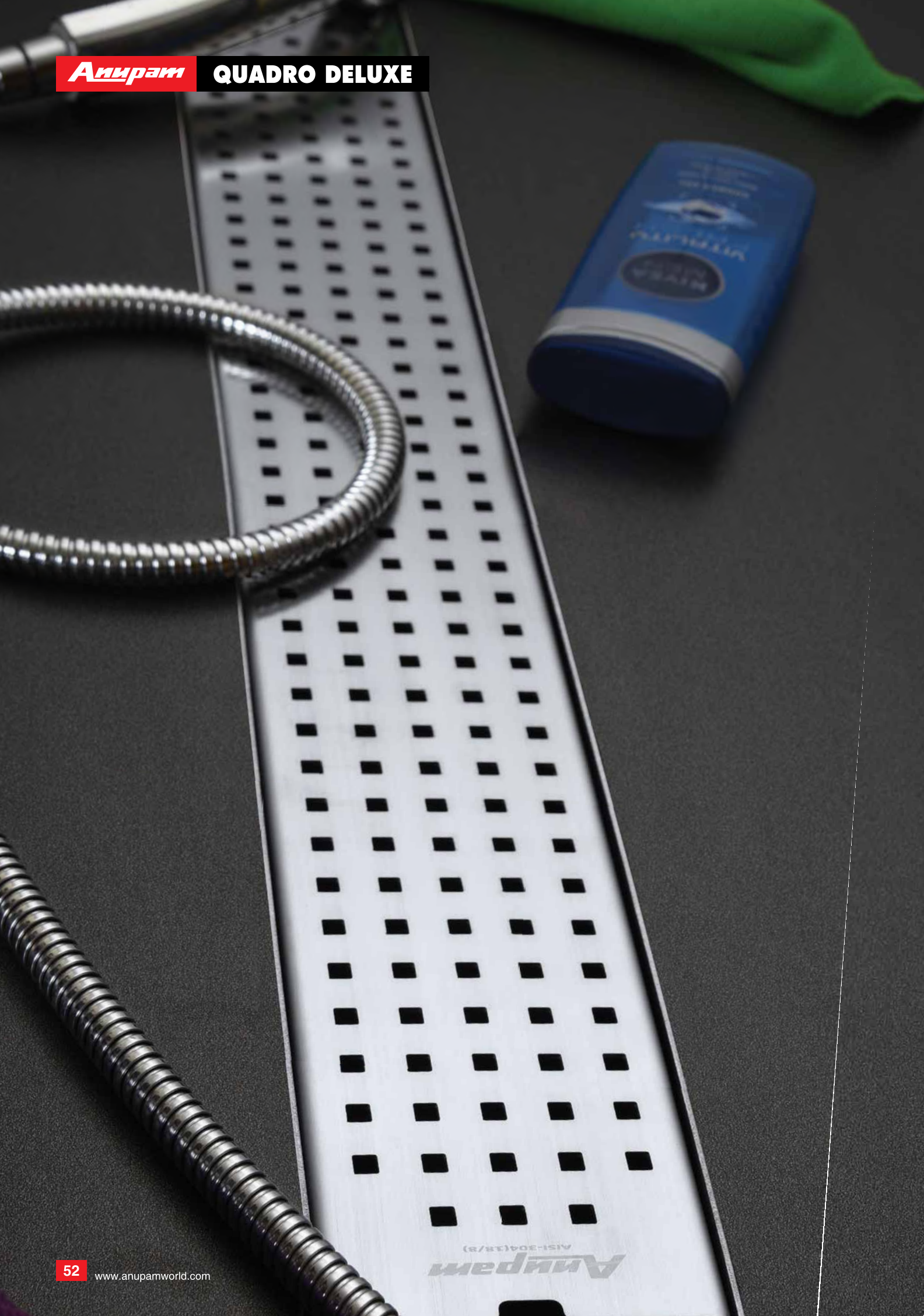

Grating Thickness 1.5mm & Frame Thickness 1.5mm

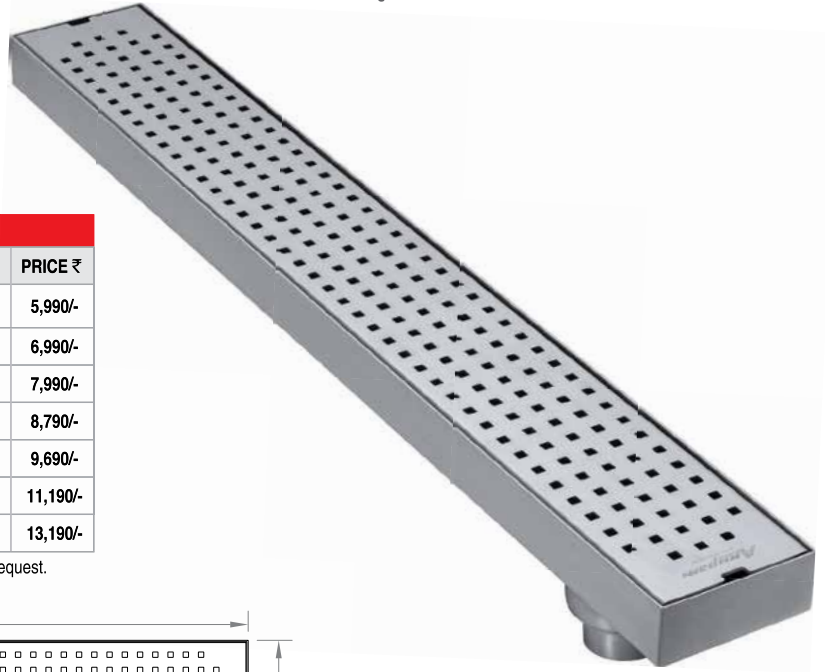

LINEAR DRAIN					
MODEL CODE	LENGTH	WIDTH	HEIGHT	OUTLET	PRICE ₹
AL-3010-88-DX	300mm	100mm	40mm	50mm	5,990/-
AL-4510-88-DX	450mm	100mm	40mm	50mm	6,990/-
AL-6010-88-DX	600mm	100mm	40mm	50mm	7,990/-
AL-7510-88-DX	750mm	100mm	40mm	50mm	8,790/-
AL-9010-88-DX	900mm	100mm	40mm	50mm	9,690/-
AL-10510-88-DX	1050mm	100mm	40mm	50mm	11,190/-
AL-12010-88-DX	1200mm	100mm	40mm	50mm	13,190/-

\*Centre Hole and different customise size are also available on request.

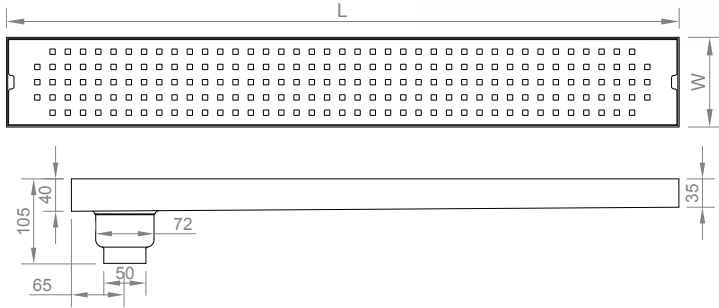

SQUARE DRAIN					
MODEL CODE	LENGTH	WIDTH	HEIGHT	OUTLET	PRICE ₹
AS-1515-88-DX	150mm	150mm	25mm	90mm	5,490/-
AS-2020-88-DX	200mm	200mm	25mm	90mm	7,090/-
AS-2525-88-DX	250mm	250mm	25mm	90mm	8,490/-
AS-3030-88-DX	300mm	300mm	25mm	90mm	9,690/-

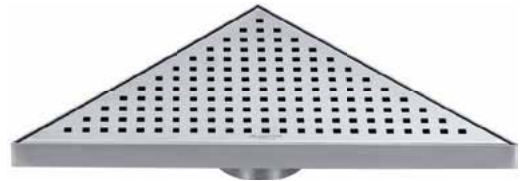
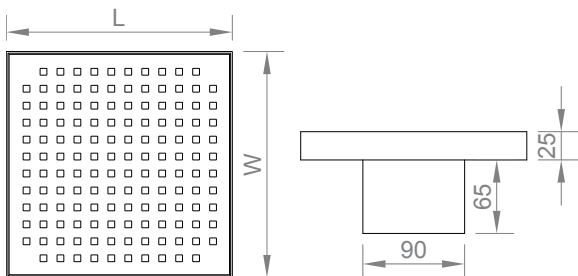

TRIANGLE DRAIN					
MODEL CODE	LENGTH	WIDTH	HEIGHT	OUTLET	PRICE ₹
AT-3030-88-DX	300mm	300mm	25mm	90mm	7,590/-

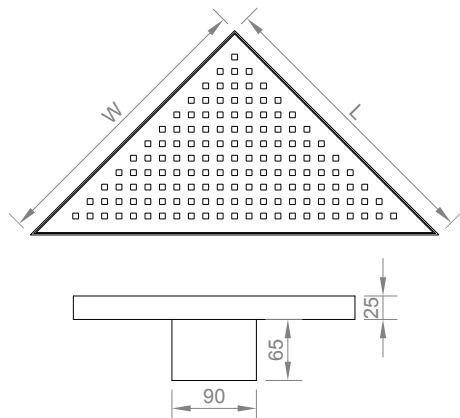





**Анупам**

**FLORO**



[www.anupamworld.com](http://www.anupamworld.com)



Grating Thickness 1.5mm & Frame Thickness 1.0mm



**LINEAR DRAIN**

MODEL CODE	LENGTH	WIDTH	HEIGHT	OUTLET	PRICE ₹
AL-3010-99	300mm	100mm	40mm	50mm	5,790/-
AL-4510-99	450mm	100mm	40mm	50mm	6,690/-
AL-6010-99	600mm	100mm	40mm	50mm	7,490/-
AL-7510-99	750mm	100mm	40mm	50mm	8,390/-
AL-9010-99	900mm	100mm	40mm	50mm	9,190/-
AL-10510-99	1050mm	100mm	40mm	50mm	10,690/-
AL-12010-99	1200mm	100mm	40mm	50mm	12,690/-

\*Centre Hole and different customise size are also available on request.

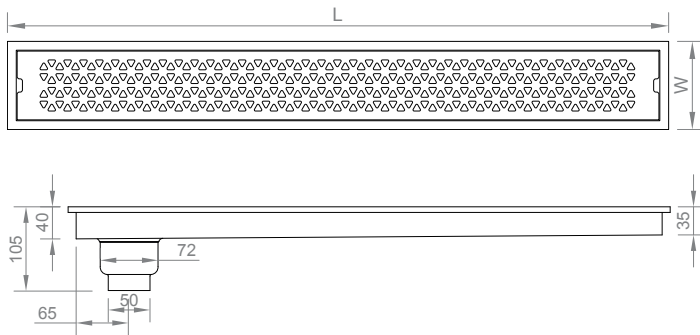

**TRIANGLE DRAIN**

MODEL CODE	LENGTH	WIDTH	HEIGHT	OUTLET	PRICE ₹
AT-3030-99	300mm	300mm	25mm	90mm	6,990/-

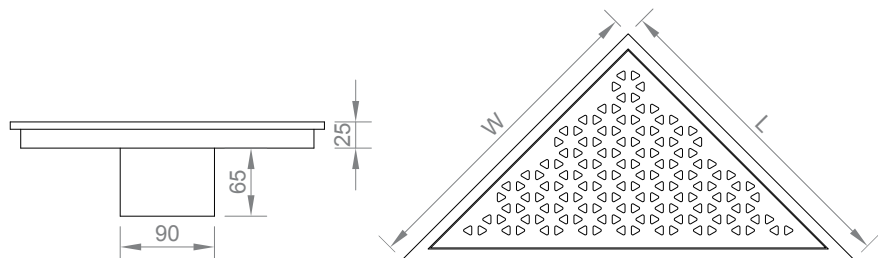
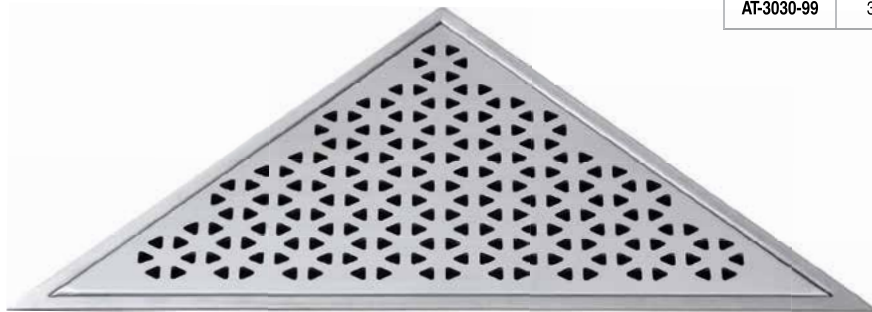

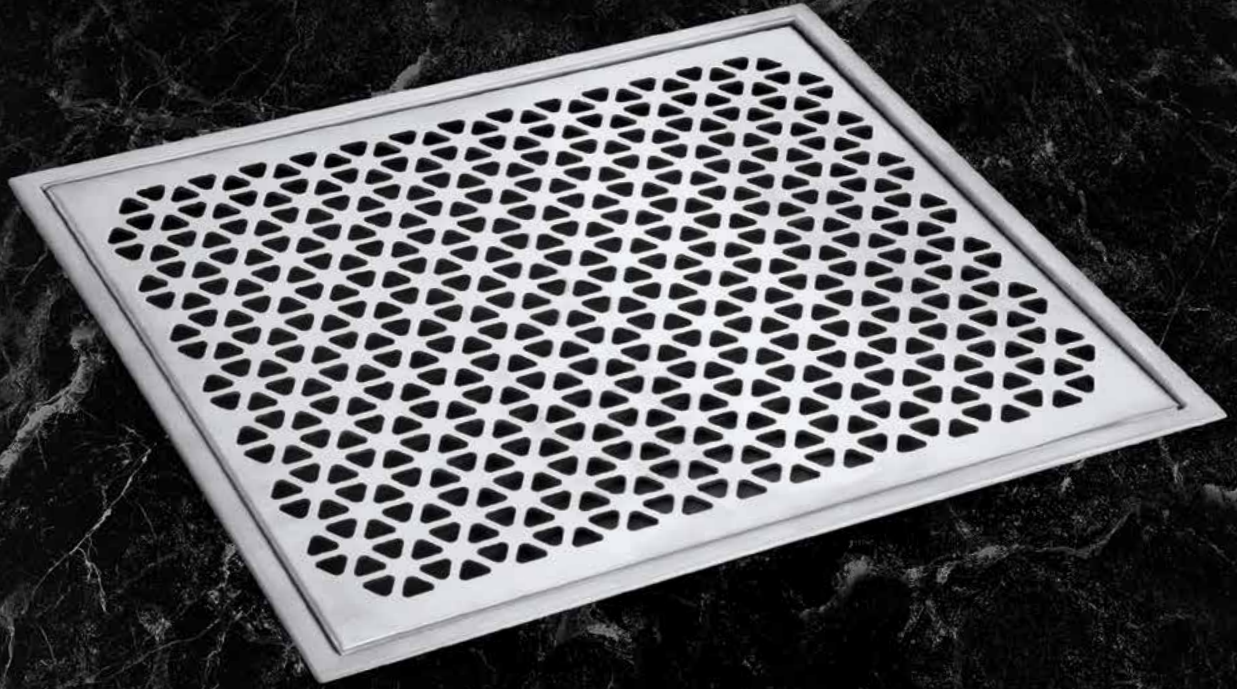

**Anupam**

**FLORO**

Grating Thickness 1.5mm & Frame Thickness 1.0mm

**SQUARE DRAIN**

MODEL CODE	LENGTH	WIDTH	HEIGHT	OUTLET	PRICE ₹
AS-1515-99	150mm	150mm	25mm	90mm	5,190/-
AS-2020-99	200mm	200mm	25mm	90mm	6,690/-
AS-2525-99	250mm	250mm	25mm	90mm	8,090/-
AS-3030-99	300mm	300mm	25mm	90mm	9,190/-

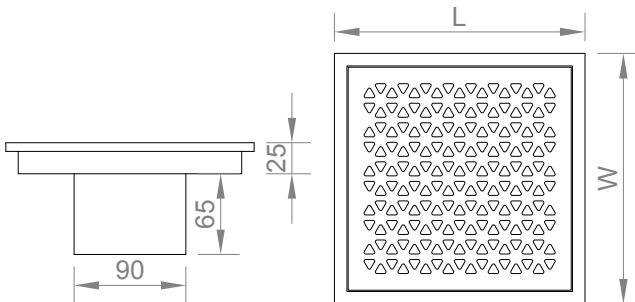



**Анупам**

**FLORO DELUXE**



Grating Thickness 1.5mm & Frame Thickness 1.5mm

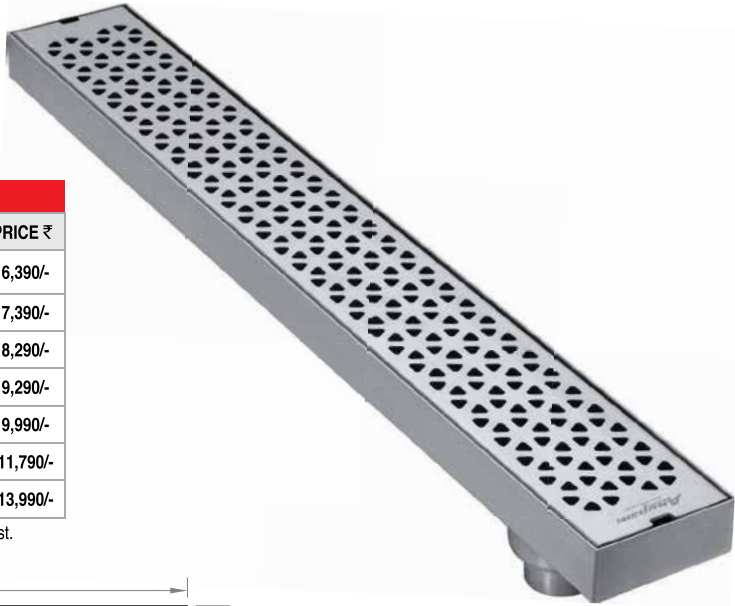

LINEAR DRAIN					
MODEL CODE	LENGTH	WIDTH	HEIGHT	OUTLET	PRICE ₹
AL-3010-99-DX	300mm	100mm	40mm	50mm	6,390/-
AL-4510-99-DX	450mm	100mm	40mm	50mm	7,390/-
AL-6010-99-DX	600mm	100mm	40mm	50mm	8,290/-
AL-7510-99-DX	750mm	100mm	40mm	50mm	9,290/-
AL-9010-99-DX	900mm	100mm	40mm	50mm	9,990/-
AL-10510-99-DX	1050mm	100mm	40mm	50mm	11,790/-
AL-12010-99-DX	1200mm	100mm	40mm	50mm	13,990/-

\*Centre Hole and different customise size are also available on request.

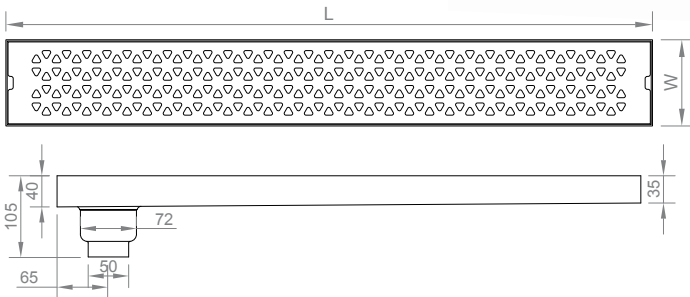

SQUARE DRAIN					
MODEL CODE	LENGTH	WIDTH	HEIGHT	OUTLET	PRICE ₹
AS-1515-99-DX	150mm	150mm	25mm	90mm	5,690/-
AS-2020-99-DX	200mm	200mm	25mm	90mm	7,390/-
AS-2525-99-DX	250mm	250mm	25mm	90mm	8,890/-
AS-3030-99-DX	300mm	300mm	25mm	90mm	9,990/-

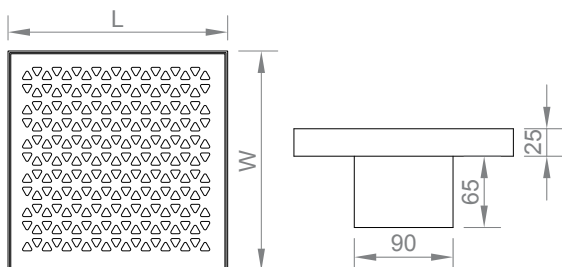

TRIANGLE DRAIN					
MODEL CODE	LENGTH	WIDTH	HEIGHT	OUTLET	PRICE ₹
AT-3030-99-DX	300mm	300mm	25mm	90mm	7,790/-

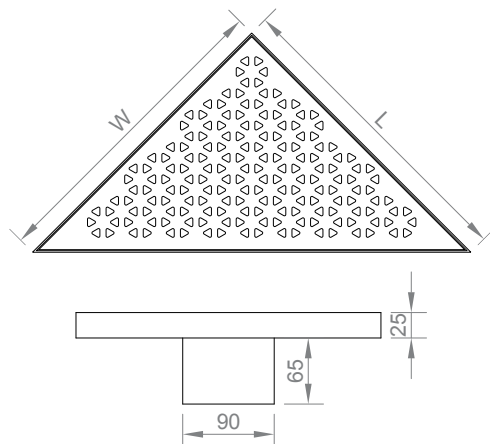



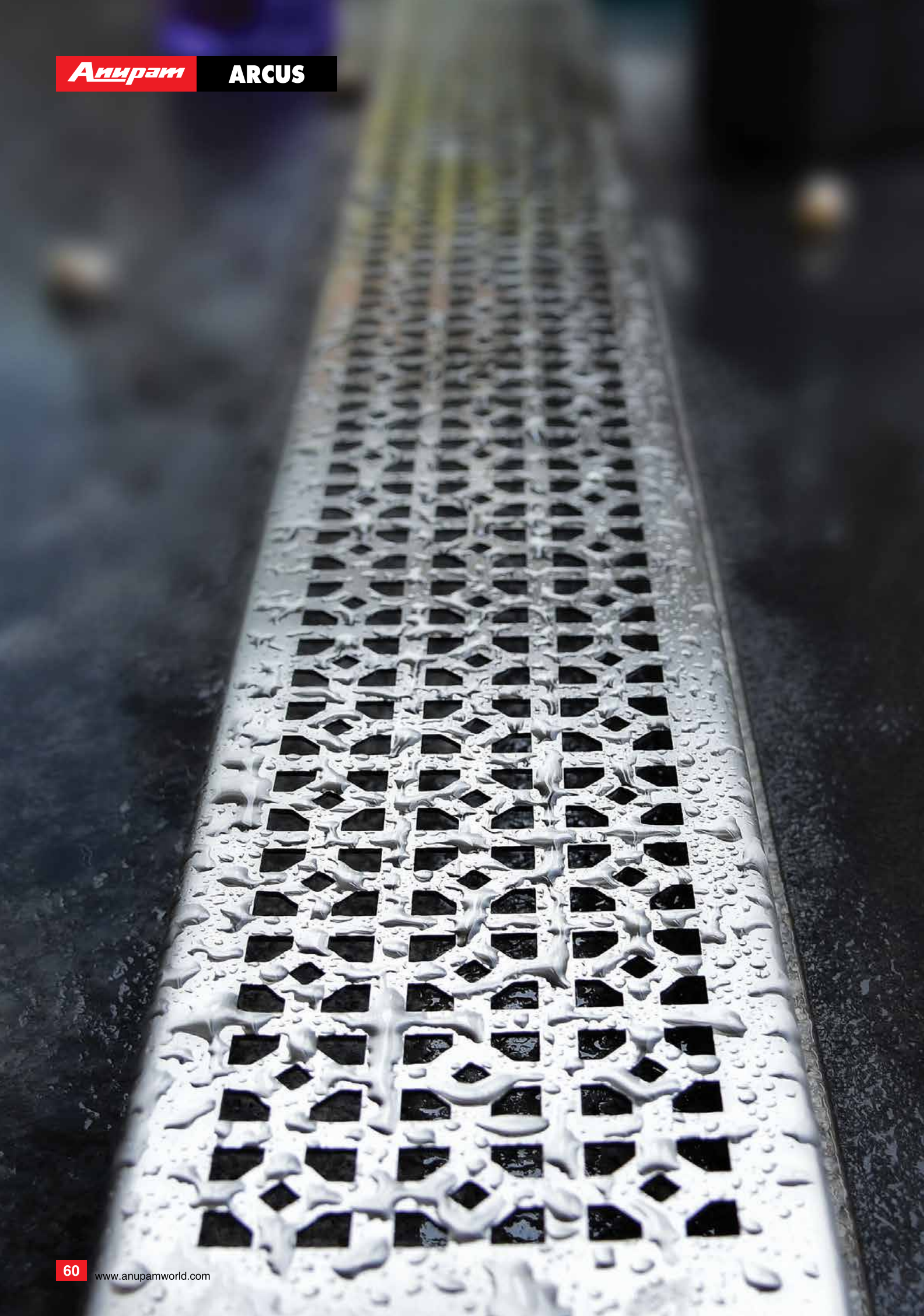

**Анираж**

**ARCUS**





Grating Thickness 1.5mm & Frame Thickness 1.0mm



**LINEAR DRAIN**

MODEL CODE	LENGTH	WIDTH	HEIGHT	OUTLET	PRICE
AL-3010-101	300mm	100mm	40mm	50mm	5,990/-
AL-4510-101	450mm	100mm	40mm	50mm	6,890/-
AL-6010-101	600mm	100mm	40mm	50mm	7,790/-
AL-7510-101	750mm	100mm	40mm	50mm	8,690/-
AL-9010-101	900mm	100mm	40mm	50mm	9,590/-
AL-10510-101	1050mm	100mm	40mm	50mm	10,990/-
AL-12010-101	1200mm	100mm	40mm	50mm	13,190/-

\*Centre Hole and different customise size are also available on request.

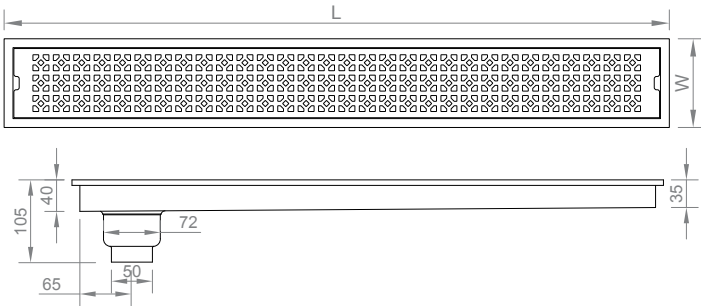

**TRIANGLE DRAIN**

MODEL CODE	LENGTH	WIDTH	HEIGHT	OUTLET	PRICE ₹
AT-3030-101	300mm	300mm	25mm	90mm	7,290/-

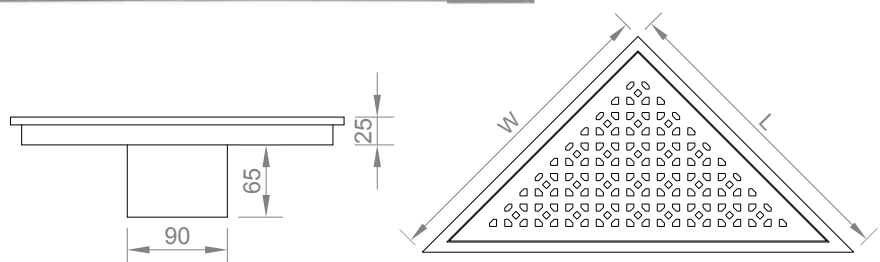
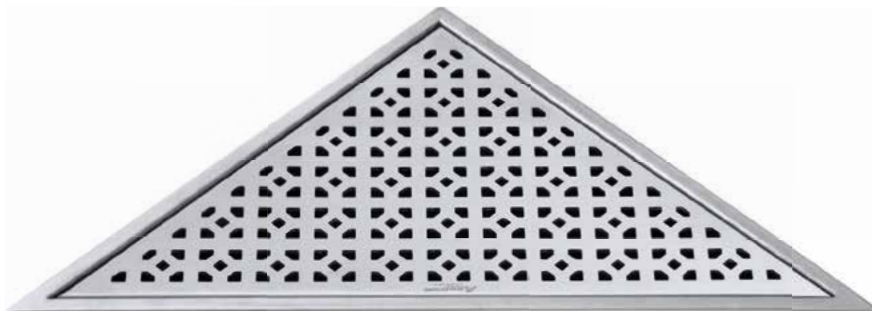

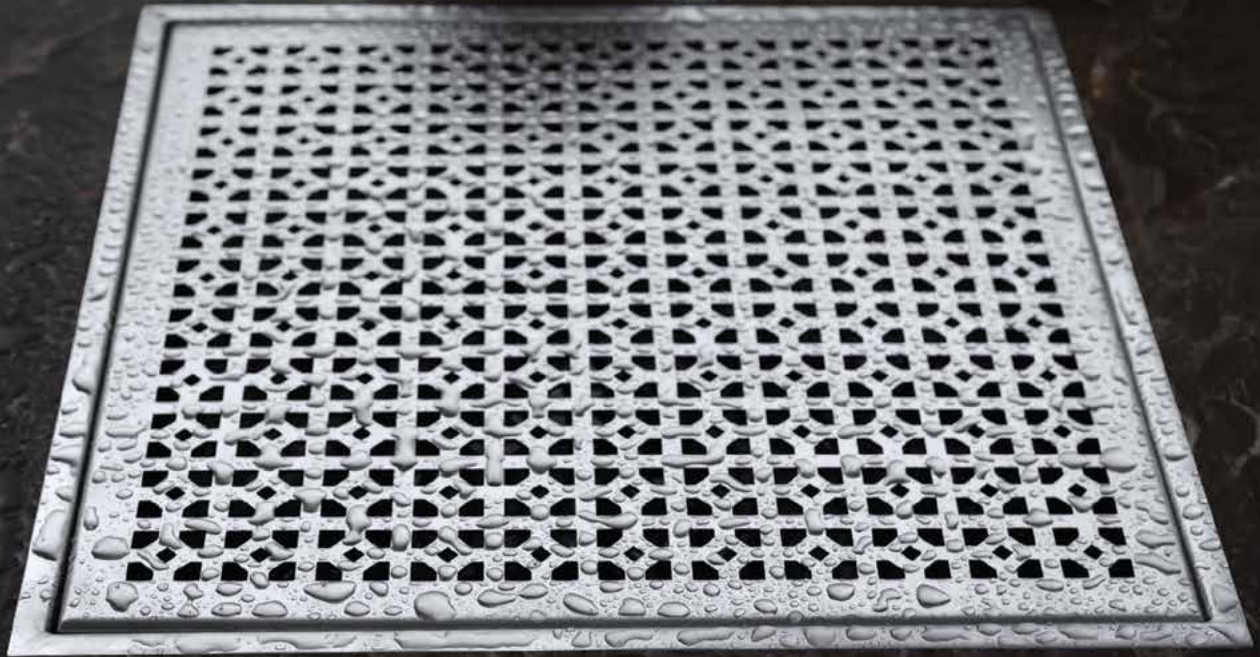

**Анупам**

**ARCUS**

Grating Thickness 1.5mm & Frame Thickness 1.0mm

**SQUARE DRAIN**

MODEL CODE	LENGTH	WIDTH	HEIGHT	OUTLET	PRICE ₹
AS-1515-101	150mm	150mm	25mm	90mm	5,390/-
AS-2020-101	200mm	200mm	25mm	90mm	6,990/-
AS-2525-101	250mm	250mm	25mm	90mm	8,390/-
AS-3030-101	300mm	300mm	25mm	90mm	9,590/-

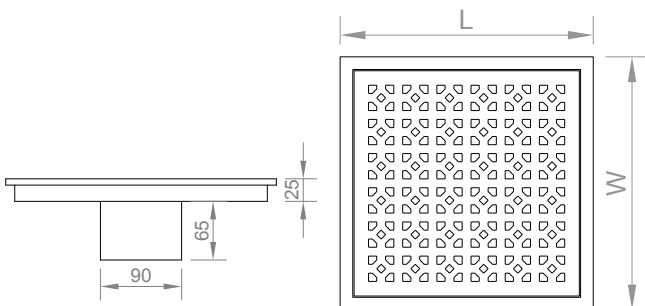



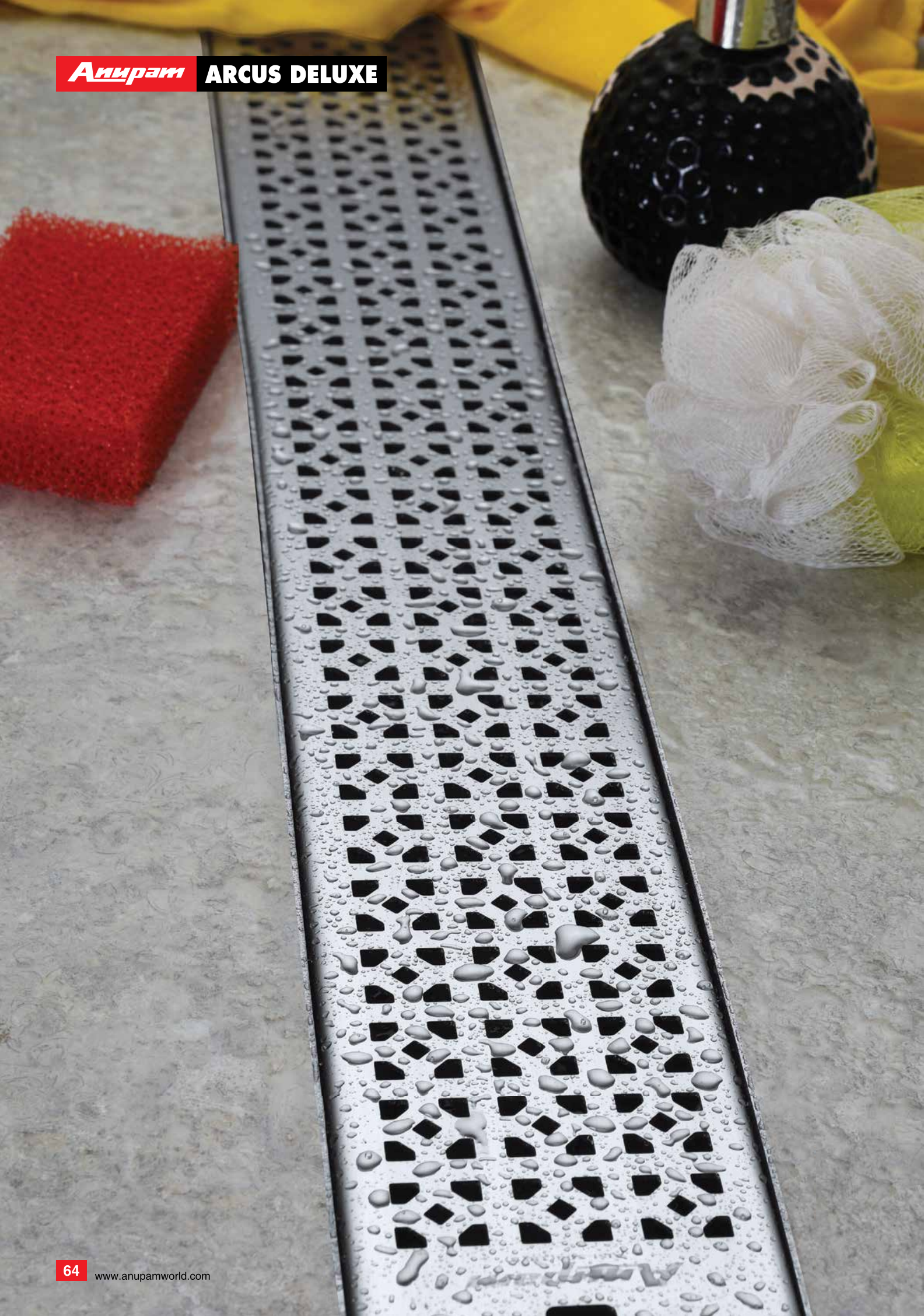

Grating Thickness 1.5mm & Frame Thickness 1.5mm



**LINEAR DRAIN**

MODEL CODE	LENGTH	WIDTH	HEIGHT	OUTLET	PRICE ₹
AL-3010-101-DX	300mm	100mm	40mm	50mm	6,590/-
AL-4510-101-DX	450mm	100mm	40mm	50mm	7,590/-
AL-6010-101-DX	600mm	100mm	40mm	50mm	8,590/-
AL-7510-101-DX	750mm	100mm	40mm	50mm	9,590/-
AL-9010-101-DX	900mm	100mm	40mm	50mm	10,590/-
AL-10510-101-DX	1050mm	100mm	40mm	50mm	11,990/-
AL-12010-101-DX	1200mm	100mm	40mm	50mm	14,490/-

\*Centre Hole and different customise size are also available on request.

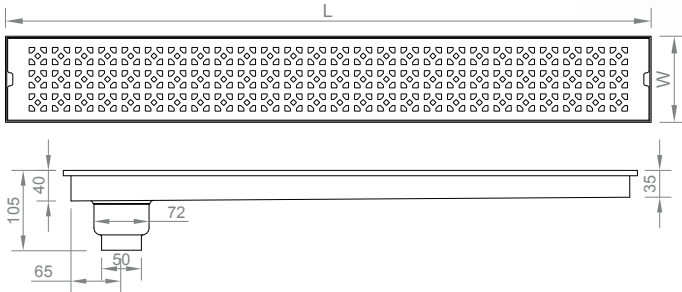

**SQUARE DRAIN**

MODEL CODE	LENGTH	WIDTH	HEIGHT	OUTLET	PRICE ₹
AS-1515-101-DX	150mm	150mm	25mm	90mm	5,990/-
AS-2020-101-DX	200mm	200mm	25mm	90mm	7,690/-
AS-2525-101-DX	250mm	250mm	25mm	90mm	9,290/-
AS-3030-101-DX	300mm	300mm	25mm	90mm	10,590/-

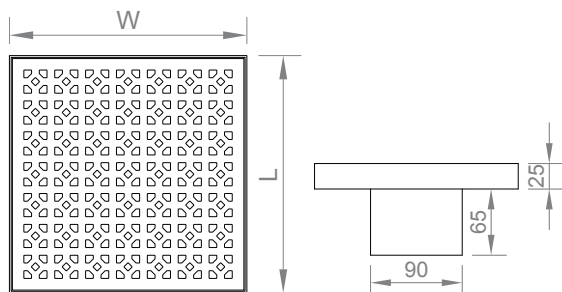

**TRIANGLE DRAIN**

MODEL CODE	LENGTH	WIDTH	HEIGHT	OUTLET	PRICE ₹
AT-3030-101-DX	300mm	300mm	25mm	90mm	7,990/-

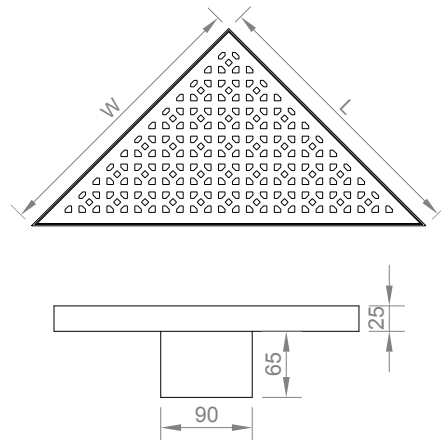





***Анираи***

**TILE INSERT**

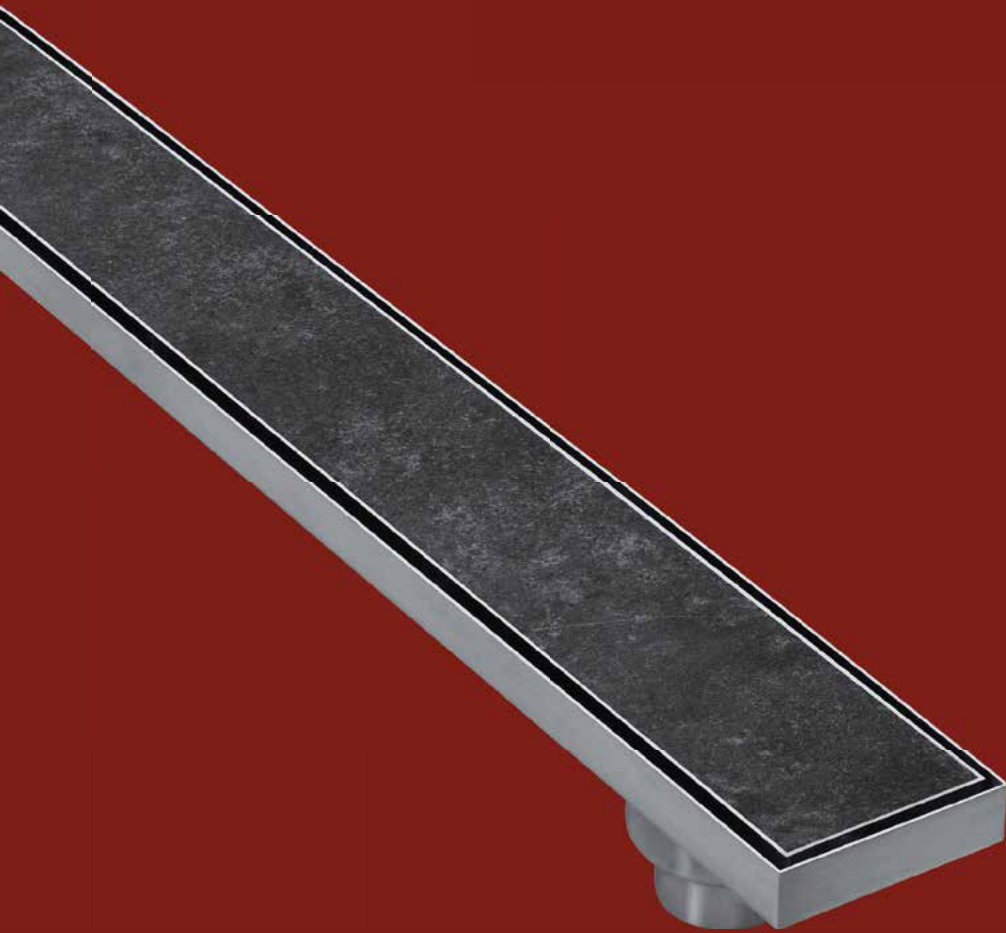



Grating Thickness 1.5mm & Frame Thickness 1.5mm



LINEAR DRAIN					
MODEL CODE	LENGTH	WIDTH	HEIGHT	OUTLET	PRICE ₹
AL-3010-102	300mm	100mm	40mm	50mm	5,790/-
AL-4510-102	450mm	100mm	40mm	50mm	6,690/-
AL-6010-102	600mm	100mm	40mm	50mm	7,490/-
AL-7510-102	750mm	100mm	40mm	50mm	8,390/-
AL-9010-102	900mm	100mm	40mm	50mm	9,190/-
AL-10510-102	1050mm	100mm	40mm	50mm	10,690/-
AL-12010-102	1200mm	100mm	40mm	50mm	12,690/-

\*Centre Hole and different customise size are also available on request.

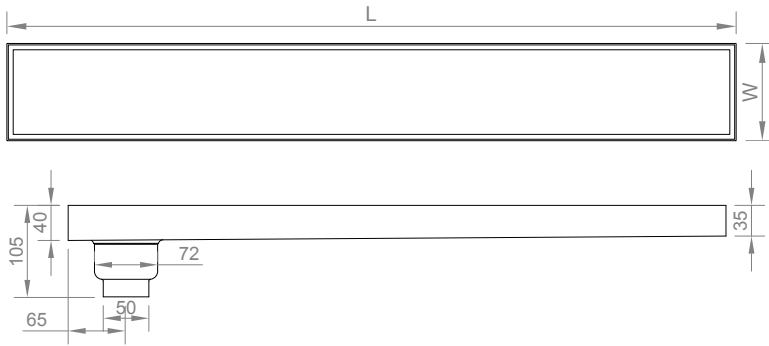

TRIANGLE DRAIN					
MODEL CODE	LENGTH	WIDTH	HEIGHT	OUTLET	PRICE ₹
AT-3030-102	300mm	300mm	25mm	90mm	6,990/-

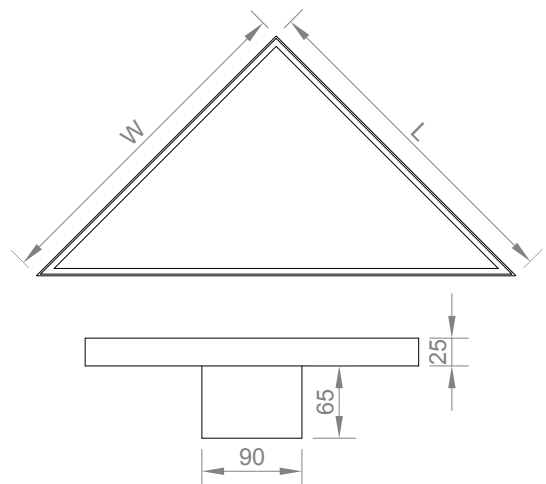



**Анупам TILE INSERT**

Grating Thickness 1.5mm & Frame Thickness 1.5mm

**SQUARE DRAIN**

MODEL CODE	LENGTH	WIDTH	HEIGHT	OUTLET	PRICE ₹
AS-1515-102	150mm	150mm	25mm	90mm	5,190/-
AS-2020-102	200mm	200mm	25mm	90mm	6,690/-
AS-2525-102	250mm	250mm	25mm	90mm	8,090/-
AS-3030-102	300mm	300mm	25mm	90mm	9,190/-

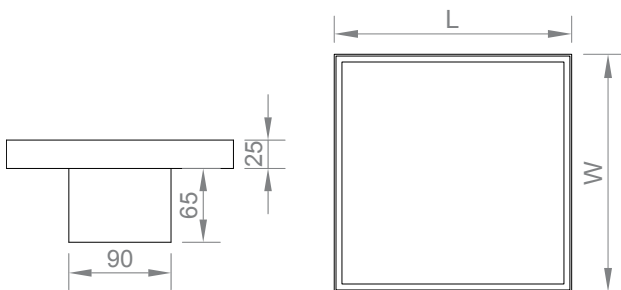





***Анираж***

## **FLOOR GRATING**







Model Code	Overall Size	Grating Thickness	MRP (Incl. of all Taxes)
A.1.R4.127B	127mm Ø / 5" Ø	1.0mm	725/-



Model Code	Overall Size	Grating Thickness	MRP (Incl. of all Taxes)
A.1.R4.127BP	127mm Ø / 5" Ø	1.0mm	725/-



Model Code	Overall Size	Grating Thickness	MRP (Incl. of all Taxes)
A.1.R4.127F	127mm Ø / 5" Ø	1.0mm	725/-
A.1.R4.140F	140mm Ø / 5.5" Ø	1.0mm	835/-



Model Code	Overall Size	Grating Thickness	MRP (Incl. of all Taxes)
A.1.R4.127FP	127mm Ø / 5" Ø	1.0mm	725/-
A.1.R4.140FP	140mm Ø / 5.5" Ø	1.0mm	835/-



Model Code	Overall Size	Grating Thickness	MRP (Incl. of all Taxes)
A.1.R4.127FH	127mm Ø / 5" Ø	1.0mm	770/-
A.1.R4.140FH	140mm Ø / 5.5" Ø	1.0mm	880/-



Model Code	Overall Size	Grating Thickness	MRP (Incl. of all Taxes)
A.1.R4.127FPH	127mm Ø / 5" Ø	1.0mm	770/-
A.1.R4.140FPH	140mm Ø / 5.5" Ø	1.0mm	880/-



Model Code	Overall Size	Grating Thickness	MRP (Incl. of all Taxes)
A.1.S4.127F	127x127mm / 5" x 5"	1.0mm	835/-
A.1.S4.140F	140x140mm / 5.5" x 5.5"	1.0mm	890/-
A.1.S4.150F	150x150mm / 6" x 6"	1.0mm	925/-



Model Code	Overall Size	Grating Thickness	MRP (Incl. of all Taxes)
A.1.S4.127FP	127x127mm / 5" x 5"	1.0mm	835/-
A.1.S4.140FP	140x140mm / 5.5" x 5.5"	1.0mm	890/-
A.1.S4.150FP	150x150mm / 6" x 6"	1.0mm	925/-



Model Code	Overall Size	Grating Thickness	MRP (Incl. of all Taxes)
A.1.S4.127FH	127x127mm / 5" x 5"	1.0mm	880/-
A.1.S4.140FH	140x140mm / 5.5" x 5.5"	1.0mm	935/-
A.1.S4.150FH	150x150mm / 6" x 6"	1.0mm	970/-



Model Code	Overall Size	Grating Thickness	MRP (Incl. of all Taxes)
A.1.S4.127FPH	127x127mm / 5" x 5"	1.0mm	880/-
A.1.S4.140FPH	140x140mm / 5.5" x 5.5"	1.0mm	935/-
A.1.S4.150FPH	150x150mm / 6" x 6"	1.0mm	970/-



Model Code	Overall Size	Grating Thickness	MRP (Incl. of all Taxes)
A.1.R2.102F	102mm Ø / 4" Ø	1.0mm	325/-
A.1.R2.127F	127mm Ø / 5" Ø	1.0mm	405/-
A.1.R2.140F	140mm Ø / 5.5" Ø	1.0mm	425/-



Model Code	Overall Size	Grating Thickness	MRP (Incl. of all Taxes)
A.1.R2.102FP	102mm Ø / 4" Ø	1.0mm	325/-
A.1.R2.127FP	127mm Ø / 5" Ø	1.0mm	405/-
A.1.R2.140FP	140mm Ø / 5.5" Ø	1.0mm	425/-





Model Code	Overall Size	Grating Thickness	MRP (Incl. of all Taxes)
A.1.R2.102FH	102mm Ø / 4" Ø	1.0mm	365/-
A.1.R2.127FH	127mm Ø / 5" Ø	1.0mm	445/-
A.1.R2.140FH	140mm Ø / 5.5" Ø	1.0mm	465/-



Model Code	Overall Size	Grating Thickness	MRP (Incl. of all Taxes)
A.1.R2.102FPH	102mm Ø / 4" Ø	1.0mm	365/-
A.1.R2.127FPH	127mm Ø / 5" Ø	1.0mm	445/-
A.1.R2.140FPH	140mm Ø / 5.5" Ø	1.0mm	465/-



Model Code	Overall Size	Grating Thickness	MRP (Incl. of all Taxes)
A.1.S2.102F	102x102mm / 4" x 4"	1.0mm	430/-
A.1.S2.127F	127x127mm / 5" x 5"	1.0mm	445/-
A.1.S2.140F	140x140mm / 5.5" x 5.5"	1.0mm	460/-
A.1.S2.150F	150x150mm / 6" x 6"	1.0mm	475/-



Model Code	Overall Size	Grating Thickness	MRP (Incl. of all Taxes)
A.1.S2.102FP	102x102mm / 4" x 4"	1.0mm	430/-
A.1.S2.127FP	127x127mm / 5" x 5"	1.0mm	445/-
A.1.S2.140FP	140x140mm / 5.5" x 5.5"	1.0mm	460/-
A.1.S2.150FP	150x150mm / 6" x 6"	1.0mm	475/-



Model Code	Overall Size	Grating Thickness	MRP (Incl. of all Taxes)
A.1.S2.102D	102x102mm / 4" x 4"	1.0mm	430/-
A.1.S2.127D	127x127mm / 5" x 5"	1.0mm	445/-
A.1.S2.140D	140x140mm / 5.5" x 5.5"	1.0mm	460/-
A.1.S2.150D	150x150mm / 6" x 6"	1.0mm	475/-



Model Code	Overall Size	Grating Thickness	MRP (Incl. of all Taxes)
A.1.S2.102DP	102x102mm / 4" x 4"	1.0mm	430/-
A.1.S2.127DP	127x127mm / 5" x 5"	1.0mm	445/-
A.1.S2.140DP	140x140mm / 5.5" x 5.5"	1.0mm	460/-
A.1.S2.150DP	150x150mm / 6" x 6"	1.0mm	475/-



Model Code	Overall Size	Grating Thickness	MRP (Incl. of all Taxes)
A.1.S2.102DH	102x102mm / 4" x 4"	1.0mm	475/-
A.1.S2.127DH	127x127mm / 5" x 5"	1.0mm	490/-
A.1.S2.140DH	140x140mm / 5.5" x 5.5"	1.0mm	505/-
A.1.S2.150DH	150x150mm / 6" x 6"	1.0mm	520/-



Model Code	Overall Size	Grating Thickness	MRP (Incl. of all Taxes)
A.1.S2.102DPH	102x102mm / 4" x 4"	1.0mm	475/-
A.1.S2.127DPH	127x127mm / 5" x 5"	1.0mm	490/-
A.1.S2.140DPH	140x140mm / 5.5" x 5.5"	1.0mm	505/-
A.1.S2.150DPH	150x150mm / 6" x 6"	1.0mm	520/-



Model Code	Overall Size	Grating Thickness	MRP (Incl. of all Taxes)
A.1.R2.102D	102mm Ø / 4" Ø	1.0mm	325/-
A.1.R2.127D	127mm Ø / 5" Ø	1.0mm	405/-
A.1.R2.140D	140mm Ø / 5.5" Ø	1.0mm	425/-



Model Code	Overall Size	Grating Thickness	MRP (Incl. of all Taxes)
A.1.R2.102DP	102mm Ø / 4" Ø	1.0mm	325/-
A.1.R2.127DP	127mm Ø / 5" Ø	1.0mm	405/-
A.1.R2.140DP	140mm Ø / 5.5" Ø	1.0mm	425/-



Model Code	Overall Size	Grating Thickness	MRP (Incl. of all Taxes)
A.1.R2.102DH	102mm Ø / 4" Ø	1.0mm	370/-
A.1.R2.127DH	127mm Ø / 5" Ø	1.0mm	450/-
A.1.R2.140DH	140mm Ø / 5.5" Ø	1.0mm	470/-



Model Code	Overall Size	Grating Thickness	MRP (Incl. of all Taxes)
A.1.R2.102DPH	102mm Ø / 4" Ø	1.0mm	370/-
A.1.R2.127DPH	127mm Ø / 5" Ø	1.0mm	450/-
A.1.R2.140DPH	140mm Ø / 5.5" Ø	1.0mm	470/-





Model Code	Overall Size	Grating Thickness	MRP (Incl. of all Taxes)
A.1.S1.80D	80x80mm / 3" x 3"	1.0mm	215/-
A.1.S1.102D	102x102mm / 4" x 4"	1.0mm	245/-
A.1.S1.127D	127x127mm / 5" x 5"	1.0mm	290/-
A.1.S1.140D	140x140mm / 5.5" x 5.5"	1.0mm	310/-
A.1.S1.150D	150x150mm / 6" x 6"	1.0mm	320/-



Model Code	Overall Size	Grating Thickness	MRP (Incl. of all Taxes)
A.1.S1.80DP	80x80mm / 3" x 3"	1.0mm	215/-
A.1.S1.102DP	102x102mm / 4" x 4"	1.0mm	245/-
A.1.S1.127DP	127x127mm / 5" x 5"	1.0mm	290/-
A.1.S1.140DP	140x140mm / 5.5" x 5.5"	1.0mm	310/-
A.1.S1.150DP	150x150mm / 6" x 6"	1.0mm	320/-



Model Code	Overall Size	Grating Thickness	MRP (Incl. of all Taxes)
A.1.R1.80D	80mm Ø / 3" Ø	1.0mm	140/-
A.1.R1.102D	102mm Ø / 4" Ø	1.0mm	160/-
A.1.R1.114D	114mm Ø / 4.5" Ø	1.0mm	185/-
A.1.R1.127D	127mm Ø / 5" Ø	1.0mm	225/-



Model Code	Overall Size	Grating Thickness	MRP (Incl. of all Taxes)
A.1.R1.80DP	80mm Ø / 3" Ø	1.0mm	140/-
A.1.R1.102DP	102mm Ø / 4" Ø	1.0mm	160/-
A.1.R1.114DP	114mm Ø / 4.5" Ø	1.0mm	185/-
A.1.R1.127DP	127mm Ø / 5" Ø	1.0mm	225/-



Model Code	Overall Size	Grating Thickness	MRP (Incl. of all Taxes)
A.1.R1.82F	82mm Ø / 3" Ø	1.0mm	235/-
A.1.R1.104F	104mm Ø / 4" Ø	1.0mm	265/-



Model Code	Overall Size	Grating Thickness	MRP (Incl. of all Taxes)
A.1.R1.82FP	82mm Ø / 3" Ø	1.0mm	235/-
A.1.R1.104FP	104mm Ø / 4" Ø	1.0mm	265/-







Model Code	Overall Size	Grating Thickness	MRP (Incl. of all Taxes)
A.2.R4.127B	127mm Ø / 5" Ø	1.0mm	725/-



Model Code	Overall Size	Grating Thickness	MRP (Incl. of all Taxes)
A.2.R4.127BP	127mm Ø / 5" Ø	1.0mm	725/-



Model Code	Overall Size	Grating Thickness	MRP (Incl. of all Taxes)
A.2.R4.127F	127mm Ø / 5" Ø	1.0mm	725/-
A.2.R4.140F	140mm Ø / 5.5" Ø	1.0mm	835/-



Model Code	Overall Size	Grating Thickness	MRP (Incl. of all Taxes)
A.2.R4.127FP	127mm Ø / 5" Ø	1.0mm	725/-
A.2.R4.140FP	140mm Ø / 5.5" Ø	1.0mm	835/-



Model Code	Overall Size	Grating Thickness	MRP (Incl. of all Taxes)
A.2.S4.127F	127x127mm / 5" x 5"	1.0mm	835/-
A.2.S4.140F	140x140mm / 5.5" x 5.5"	1.0mm	890/-
A.2.S4.150F	150x150mm / 6" x 6"	1.0mm	925/-



Model Code	Overall Size	Grating Thickness	MRP (Incl. of all Taxes)
A.2.S4.127FP	127x127mm / 5" x 5"	1.0mm	835/-
A.2.S4.140FP	140x140mm / 5.5" x 5.5"	1.0mm	890/-
A.2.S4.150FP	150x150mm / 6" x 6"	1.0mm	925/-



Model Code	Overall Size	Grating Thickness	MRP (Incl. of all Taxes)
A.2.R2.102F	102mm Ø / 4" Ø	1.0mm	325/-
A.2.R2.127F	127mm Ø / 5" Ø	1.0mm	405/-
A.2.R2.140F	140mm Ø / 5.5" Ø	1.0mm	425/-



Model Code	Overall Size	Grating Thickness	MRP (Incl. of all Taxes)
A.2.R2.102FP	102mm Ø / 4" Ø	1.0mm	325/-
A.2.R2.127FP	127mm Ø / 5" Ø	1.0mm	405/-
A.2.R2.140FP	140mm Ø / 5.5" Ø	1.0mm	425/-



Model Code	Overall Size	Grating Thickness	MRP (Incl. of all Taxes)
A.2.S2.102F	102x102mm / 4" x 4"	1.0mm	430/-
A.2.S2.127F	127x127mm / 5" x 5"	1.0mm	445/-
A.2.S2.140F	140x140mm / 5.5" x 5.5"	1.0mm	460/-
A.2.S2.150F	150x150mm / 6" x 6"	1.0mm	475/-



Model Code	Overall Size	Grating Thickness	MRP (Incl. of all Taxes)
A.2.S2.102FP	102x102mm / 4" x 4"	1.0mm	430/-
A.2.S2.127FP	127x127mm / 5" x 5"	1.0mm	445/-
A.2.S2.140FP	140x140mm / 5.5" x 5.5"	1.0mm	460/-
A.2.S2.150FP	150x150mm / 6" x 6"	1.0mm	475/-



Model Code	Overall Size	Grating Thickness	MRP (Incl. of all Taxes)
A.2.R1.82F	82mm Ø / 3" Ø	1.0mm	235/-
A.2.R1.104F	104mm Ø / 4" Ø	1.0mm	265/-



Model Code	Overall Size	Grating Thickness	MRP (Incl. of all Taxes)
A.2.R1.82FP	82mm Ø / 3" Ø	1.0mm	235/-
A.2.R1.104FP	104mm Ø / 4" Ø	1.0mm	265/-





Model Code	Overall Size	Grating Thickness	MRP (Incl. of all Taxes)
A.3.R4.127B	127mm Ø / 5" Ø	1.0mm	725/-



Model Code	Overall Size	Grating Thickness	MRP (Incl. of all Taxes)
A.3.R4.127BP	127mm Ø / 5" Ø	1.0mm	725/-



Model Code	Overall Size	Grating Thickness	MRP (Incl. of all Taxes)
A.3.R4.127F	127mm Ø / 5" Ø	1.0mm	725/-
A.3.R4.140F	140mm Ø / 5.5" Ø	1.0mm	835/-



Model Code	Overall Size	Grating Thickness	MRP (Incl. of all Taxes)
A.3.R4.127FP	127mm Ø / 5" Ø	1.0mm	725/-
A.3.R4.140FP	140mm Ø / 5.5" Ø	1.0mm	835/-



Model Code	Overall Size	Grating Thickness	MRP (Incl. of all Taxes)
A.3.S4.127F	127x127mm / 5" x 5"	1.0mm	835/-
A.3.S4.140F	140x140mm / 5.5" x 5.5"	1.0mm	890/-
A.3.S4.150F	150x150mm / 6" x 6"	1.0mm	925/-



Model Code	Overall Size	Grating Thickness	MRP (Incl. of all Taxes)
A.3.S4.127FP	127x127mm / 5" x 5"	1.0mm	835/-
A.3.S4.140FP	140x140mm / 5.5" x 5.5"	1.0mm	890/-
A.3.S4.150FP	150x150mm / 6" x 6"	1.0mm	925/-



Model Code	Overall Size	Grating Thickness	MRP (Incl. of all Taxes)
A.3.R2.102F	102mm Ø / 4" Ø	1.0mm	325/-
A.3.R2.127F	127mm Ø / 5" Ø	1.0mm	405/-
A.3.R2.140F	140mm Ø / 5.5" Ø	1.0mm	425/-



Model Code	Overall Size	Grating Thickness	MRP (Incl. of all Taxes)
A.3.R2.102FP	102mm Ø / 4" Ø	1.0mm	325/-
A.3.R2.127FP	127mm Ø / 5" Ø	1.0mm	405/-
A.3.R2.140FP	140mm Ø / 5.5" Ø	1.0mm	425/-



Model Code	Overall Size	Grating Thickness	MRP (Incl. of all Taxes)
A.3.S2.102F	102X102mm / 4" x 4"	1.0mm	430/-
A.3.S2.127F	127x127mm / 5" x 5"	1.0mm	445/-
A.3.S2.140F	140x140mm / 5.5" x 5.5"	1.0mm	460/-
A.3.S2.150F	150x150mm / 6" x 6"	1.0mm	475/-



Model Code	Overall Size	Grating Thickness	MRP (Incl. of all Taxes)
A.3.S2.102FP	102X102mm / 4" x 4"	1.0mm	430/-
A.3.S2.127FP	127x127mm / 5" x 5"	1.0mm	445/-
A.3.S2.140FP	140x140mm / 5.5" x 5.5"	1.0mm	460/-
A.3.S2.150FP	150x150mm / 6" x 6"	1.0mm	475/-



Model Code	Overall Size	Grating Thickness	MRP (Incl. of all Taxes)
A.3.R1.82F	82mm Ø / 3" Ø	1.0mm	235/-
A.3.R1.104F	104mm Ø / 4" Ø	1.0mm	265/-



Model Code	Overall Size	Grating Thickness	MRP (Incl. of all Taxes)
A.3.R1.82FP	82mm Ø / 3" Ø	1.0mm	235/-
A.3.R1.104FP	104mm Ø / 4" Ø	1.0mm	265/-





**VERTICAL GRATING WITH FRAME**

Model Code	Overall Size	Grating Thickness	MRP (Incl. of all Taxes)
A.4.V2.1560F	150x600mm / 6" x 24"	1.0mm	3790
A.4.V2.2060F	200x600mm / 8" x 24"	1.0mm	4790
A.4.V2.2560F	250x600mm / 10" x 24"	1.0mm	5390
A.4.V2.3060F	300x600mm / 12" x 24"	1.0mm	5990



**VERTICAL GRATING WITHOUT FRAME**

Model Code	Overall Size	Grating Thickness	MRP (Incl. of all Taxes)
A.4.V1.1560	150x600mm / 6" x 24"	1.0mm	2690
A.4.V1.2060	200x600mm / 8" x 24"	1.0mm	3390
A.4.V1.2560	250x600mm / 10" x 24"	1.0mm	3890
A.4.V1.3060	300x600mm / 12" x 24"	1.0mm	4290



**VERTICAL GRATING WITH FRAME**

Model Code	Overall Size	Grating Thickness	MRP (Incl. of all Taxes)
A.4.V2.1515F	150x150mm / 6" x 6"	1.0mm	2590/-
A.4.V2.2020F	200x200mm / 8" x 8"	1.0mm	2990/-
A.4.V2.2525F	250x250mm / 10" x 10"	1.0mm	3390/-
A.4.V2.3030F	300x300mm / 12" x 12"	1.0mm	3890/-



**VERTICAL GRATING WITHOUT FRAME**

Model Code	Overall Size	Grating Thickness	MRP (Incl. of all Taxes)
A.4.V1.88	80x80mm / 3" x 3"	1.0mm	275
A.4.V1.1010	106x106mm / 4" x 4"	1.0mm	350
A.4.V1.1313	130x130mm / 5" x 5"	1.0mm	425
A.4.V1.1515	150x150mm / 6" x 6"	1.0mm	525
A.4.V1.2020	200x200mm / 8" x 8"	1.0mm	1090
A.4.V1.2525	250x250mm / 10" x 10"	1.0mm	1550
A.4.V1.3030	300x300mm / 12" x 12"	1.0mm	2090



### CLEAN-OUT COVER

Model Code	Overall Size	Grating Thickness	MRP (Incl. of all Taxes)
A.4.R2.102C	102mm Ø / 4 Ø	1.0mm	520
A.4.R2.127C	127mm Ø / 5 Ø	1.0mm	560
A.4.R2.140C	140mm Ø / 5.5 Ø	1.0mm	590



### CLEAN-OUT COVER

Model Code	Overall Size	Grating Thickness	MRP (Incl. of all Taxes)
A.4.S2.102C	102x102mm / 4 x 4	1.0mm	550
A.4.S2.127C	127x127mm / 5 x 5	1.0mm	590
A.4.S2.140C	140x140mm / 5.5 x 5.5	1.0mm	530
A.1.S2.150C	150x150mm / 6 x 6	1.0mm	690



### FLANGE-01

Model Code	Overall Size	Grating Thickness	MRP (Incl. of all Taxes)
A.4.R1.01	68mm	1.0mm	40/-



### FLANGE-02

Model Code	Overall Size	Grating Thickness	MRP (Incl. of all Taxes)
A.4.R1.02	72mm	1.0mm	55/-



### FLANGE-03

Model Code	Overall Size	Grating Thickness	MRP (Incl. of all Taxes)
A.4.R1.03	72mm	1.0mm	55



### FLANGE-04

Model Code	Overall Size	Grating Thickness	MRP (Incl. of all Taxes)
A.4.R1.04	82mm	1.0mm	65/-



# Анират

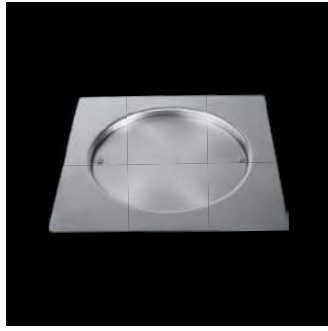
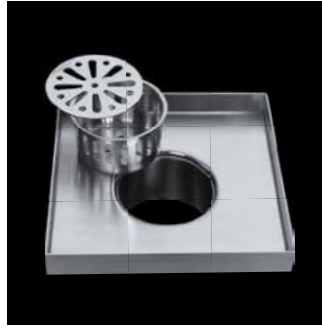

## **TERMS & CONDITIONS**

**Pricing:** Suggested list prices and product specifications are subject to change without notice. Pricing for India purchase only.

**Taxes:** Prices are inclusive of GST, state and local taxes will be extra when applicable.

**Loss and/or Damage in Transit:** Our liability ceases upon delivery of the goods to the carrier at our warehouse. Claims for damage and/or loss in transit to be made by the consignee against the carrier.

**Freight:** Prices are exclusive of freight.

**Outer Packing:** For a nominal charge, a drainer will be repackaged to further reduce damage that could occur during shipment. Outer packaging must be requested when the order is submitted.

**Returned Goods:** Returns will not be accepted without prior written authorization from Anupam. Handling and reconditioning charges will be assessed and will be charged accordingly as required to restore the items to saleable condition.

**Cancellation:** On custom-made or standard models designed to customer's specifications, an engineering charge will be assessed if order is cancelled before fabrication has commenced. Cancellation after fabrication/alteration is started will result in a charge commensurate with the extent of work completed.

**Jurisdiction:** Subject to Delhi Court Jurisdiction.

**Effective:** This price list effective from 15th August 2018.



**Анираत**



**GARG SONS INDIA PVT, LTD.**

5, HSIDC Industrial Estate, Phase-1

Kundli- 131028 Haryana, INDIA

Email: [info@anupamsinks.com](mailto:info@anupamsinks.com)

[www.anupamworld.com](http://www.anupamworld.com)

Toll Free: 1800 110 123

